



Beyond



TM

**Factory
Automation**

PLC / HMI / Motion Controller / Servo / Gearbox



vector
Energy

LS ELECTRIC

LS Smart Factory Automation Solutions

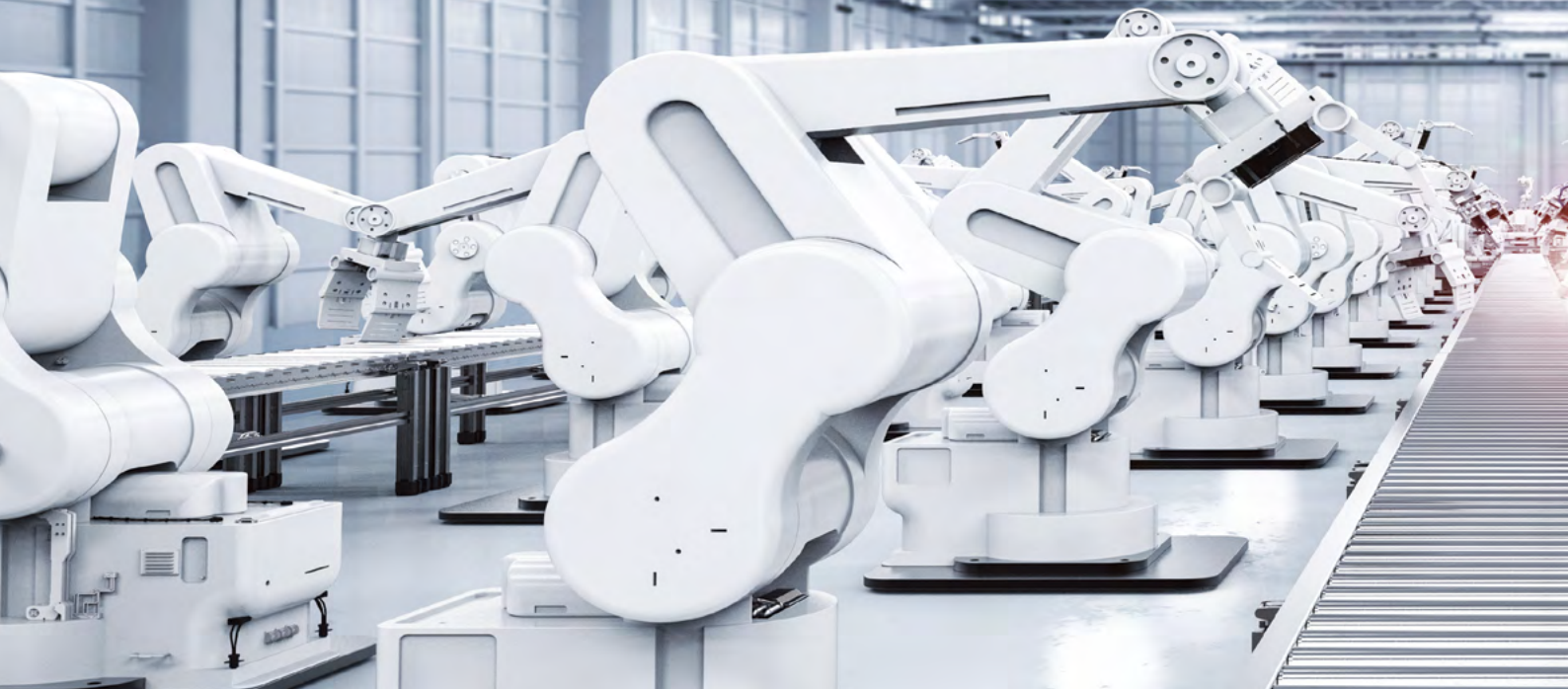

Full line up for factory automation from controller to devices for your total automation system



PLC & Smart I/O

XGT Series

- XGR (Redundancy) • XGI (IEC)
- XGK (Ladder)
- XGB

Smart I/O

- Ethernet based block/Expansion type
- Serial based block/Expansion type
- EtherCAT based / Expansion type



Motion Controller

Motion Controller

- XMC-E08/16/32A
(8/16/32 axes, Analog)
- XMC-E32C (32 axes, Cnet)



HMI

XGT Panel

- iXP3 (Premium)
- LXP (Premium)
- iXP2 (Premium)
- eXP2 (Standard)
- iXP2H (Handyheld)

SCADA software

- XGT InfoU (SCADA)
- XPC (Panel PC)



Servo System

Xmotion (Servo drive & Motor)

AC Servo Drives

- iX7NH Series(EtherCAT)
- L7C Series (Pulse command)
- L7P Series
(Pulse drive with indexer mode)
- L7NH Series (EtherCAT)

DC Servo Drives

- PHOX Series (EtherCAT)

Servo Motors

- F Series (Rotary type)
- MDM Series (Direct drive type)

Integrated Servo Motors

- Pegasus series (EtherCAT)

Gearbox

Helical Gear

- Straight type : MSS / MSR / MSO
- Angular type : MAS / MAR / MAO
- Straight type : HSS / HSR / HSW / HSD
- Angular type : HAS / HAR / HAW / HAD

Spur Gear

- Straight type : SSS / SSO / SSR
- Angular type : SAS / SAO / SAR

PLC XGR | Redundancy System PLC Based on IEC



Features

High Performance

- Processing speed : 42ns/step
- CPU synchronization via fiber optic cable
- I/O points : Max. 131,072
- Total memory : 25MB (Program 7MB, Data 2MB, Flash 16MB)
- Switching over time : min. 4.3ms/max. 22ms

Easy Expansion Installation Using Network

- Max. 31 expansion base
 - Distance : Fiber Multi type 2km, Single type 15km (Max. expansion 60km)
 - Twisted pair 100m (Max. expansion 3km)
- Program upload and download via expansion base
- No limit to install the communication master on the expansion base

Enhanced Maintenance Via System History and Network Ring Configuration

- Convenient system analysis using operation history, Error history, System history
- Ring configuration to prevent a line disconnection error
- Network monitoring, Protocol monitoring function
- Error channel monitoring via flag
- Graphic display for the system configuration
- Safe module exchange via wizard

IEC 61131-3 Standard Language

- LD, ST, SFC, IL (Read only)
- Program configuration and data type based on IEC

Variety of Communication Functions

- Easy interface using open network (Ethernet, Profibus-DP, DeviceNet, RS-232C, RS-422/485, etc.)
- Max. 24 communication module installation on the expansion base (High speed link 12, P2P 8)
- Network diagnosis via network and frame monitoring
- PLC link via dedicated communication based on Ethernet (RAPIenet)

Variety of Input and Output Modules

- 8/16/32/64 points (8/16 points relay output)
- Input/output /Mixed module

Enhanced Analog Function

- Enable to install the analog module on the expansion base (Max. 250, Analog input 139)
- Insulated type and temperature modules
- Easy to set the parameter via I/O parameter and flag
- Debugging function via special module monitoring

Integrated Programming & Engineering Environment

- XG5000 : Easy to program, Various monitoring functions and enhanced editing function
- XG-PD : Convenient setup for communication and network parameter
- XG-PM : Software package for positioning module
- XG-TCO : Temperature control and function of auto tuning

System Configuration Diagram

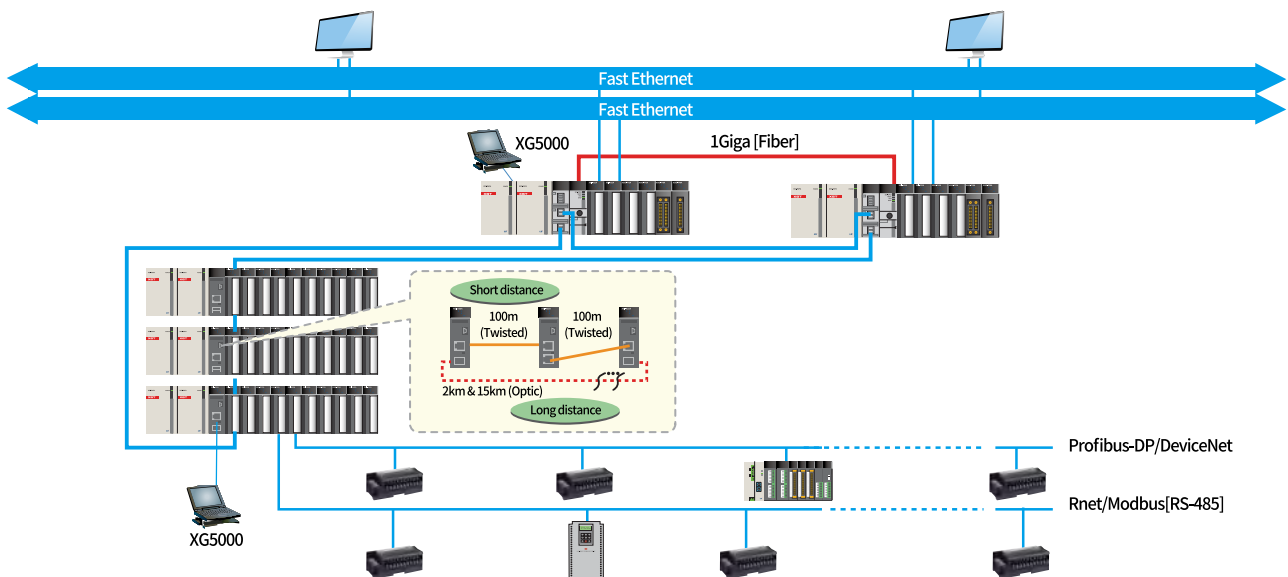

System Configuration

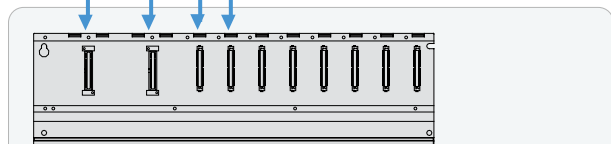
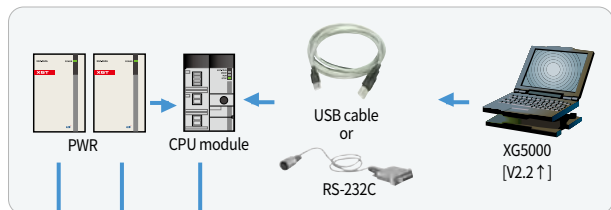

Main base [A Side] XGR-M06P / XGR-M02P

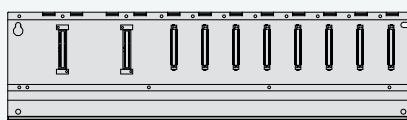

Main base [B Side] XGR-M06P / XGR-M02P

Main base

- 2 types of CPU (Fiber optic, Twisted fair)
- Power : AC110V, AC220V
- 6slot base : Enable to install 6 communication modules

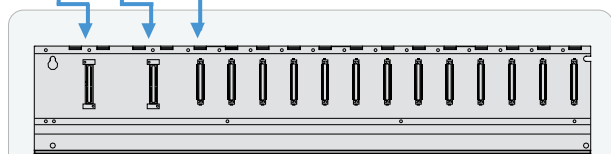
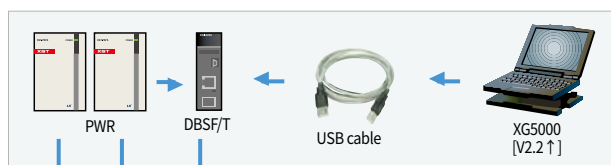

Expansion base XGR-E12P / XGR-E12H

Expansion base

- Power 8.5A/AC110V, 8.5A/AC220V
- Expansion drive : Fiber optic, Twisted fair, Hybrid
- EFM* and EIM* not available with 12slot base

Item	XGR Module	
CPU	XGR-CPUH/T	Twisted pair
	XGR-CPUH/F	Fiber optic (2km)
	XGR-CPUH/S	Fiber optic (15km)
Power	XGR-AC12	110V, 5.5A (Main base)
	XGR-AC13	110V, 8.5A (Expansion base)
	XGR-AC22	220V, 5.5A (Main base)
	XGR-AC23	220V, 8.5A (Expansion base)
Base	XGR-DC42	DC24V/DC5V 7A, Main (Expansion base)
	XGR-M02P	2slot (Main base)
	XGR-M06P	6slot (Main base)
	XGR-E08P	8slot (Expansion base)
	XGR-E12P	12slot (Expansion base)
Expansion Drive	XGR-E12H	12slot (Expansion base, Drive redundancy)
	XGR-DBST	Twisted pair - Twisted
	XGR-DBSF	Pair fiber optic - Fiber optic(2km)
	XGR-DBSH	Twisted pair - Fiber optic(2km)
	XGR-DBSFS	Pair fiber optic - Fiber optic(15km)
	XGR-DBSHS	Twisted pair - Fiber optic(15km)

Item	XGR Module	
Expansion Drive	XGR-DBDT	Twisted pair - Twisted
Redundancy	XGR-DBDF	Pair fiber optic-Fiber optic(2km)
Sync & Expansion Cable	XGR-DBDH	Twisted pair - Fiber optic(2km)
	XGC-F201	2m (Fiber optic)
	XGC-F501	5m (Fiber optic)

Item	Input Module		
	AC110V	AC220V	DC24V
8 points	-	XGI-A21A, XGI-A21C	XGI-D21A
16 points	XGI-A12A	-	XGI-D22A
	-	-	XGI-D22B
32 points	-	-	XGI-D24A
	-	-	XGI-D24B
64 points	-	-	XGI-D28A
	-	-	XGI-D28B

Item	Output Module		
	Relay	Triac	Transistor
8 points	XGQ-RY1A	-	XGQ-TR1C
16 points	XGQ-RY2A	XGQ-SS2A	XGQ-TR2A
	XGQ-RY2B	-	XGQ-TR2B
32 points	-	-	XGQ-TR4A
	-	-	XGQ-TR4B
64 points	-	-	XGQ-TR8A
	-	-	XGQ-TR8B

Item	Special Module	
Analog Input	XGF-AV8A	Voltage input type, 8ch
	XGF-AC8A	Current input type, 8ch
	XGF-AD8A	Voltage/ Current input, 8ch
	XGF-AD4S	Voltage/ Current input, 4ch (Isolated)
	XGF-AD16A	Voltage/ Current input, 16ch
	XGF-AW4S	2-wire, Voltage/ Current input, 4ch (Isolated)
Analog Output	XGF-DV4A	Voltage output type, 4ch
	XGF-DC4A	Current output type, 4ch
	XGF-DV8A	Voltage output type, 8ch
	XGF-DC8A	Current output type, 8ch
	XGF-DV4S	Voltage output, 4ch (Isolated)
	XGF-DC4S	Current output, 4ch (Isolated)
Analog Input/Output	XGF-DA4S	Voltage/Current output, 4ch (Isolated)
	XGF-AH6A	Input : 4ch, Voltage/ Current Output : 2ch voltage/ Current
High-Speed Counter	XGF-HO2A	Pulse (OC) input type, 2ch
	XGF-HD2A	Pulse (LD) input type, 2ch
Positioning	XGF-PO1H~PO4H	Open collector, 1~4axis
	XGF-PD1H~PD4H	Line drive, 1~4axis
Positioning (Network Type)	XGF-PN8A	LS standard EtherCAT 8 axes
	XGF-PN8B	Standard EtherCAT 8 axes
Motion Module	XGF-M32E	Standard EtherCAT 32 axes
Temperature Control	XGF-TC4S	Thermocouple input, 4ch
	XGF-RD4A	RTD input, 4ch
	XGF-RD4S	RTD input, 4ch (Insulated)
	XGF-TC4UD	Input : 4ch. (Voltage/Current, RTD/TC) Output : 8ch. (TR/Current) Controller : 4 loops
Temperature Controller	XGF-TC4RT	Input : 4ch. (RTD) Output : 4ch. (TR) Controller : 4 loops
	XGF-SOEA	DC24V, 32points

Item	Communication Module	
OPCUA	XGL-EOPCT	OPC UA, Twisted fair 2Ch
RAPIenet+ - RAPIenetv2 - EtherNet/IP	XGL-EFMTB	Master/client, Twisted fair 2ch.
	XGL-EFMFB	Master/client, Fiber optic 2ch.
- Modbus TCP/IP - Dedicated XGT Network	XGL-EFMHB	Master/client, Twisted fair/fiber optic
	XOL-ES4T	Stand alone switch twisted pair 4ch.
	XOL-ES4H	Stand alone switch twisted 2ch. fiber 2ch.
	XGL-EH5T	Open Ethernet switching hub
Computer Link (Cnet)	XGL-CH2B	RS-232C 1ch., RS-422/485 1ch.
	XGL-C22B	RS-232C 2ch.
	XGL-C42B	RS-422/485 2ch.
DeviceNet (Dnet)	XGL-DMEB	DeviceNet, Master
	XGL-DSEB	DeviceNet, Slave
Profibus-DP (Pnet)	XGL-PMEB	Profibus-DP, Master
	XGL-PSRA	Profibus-DP Slave, Remote interface
	XGL-PSEA	Profibus-DP Slave
Rnet	XGL-RMEB	Rnet, Master, TP
Fnet	GOL-RR8T	Rnet stand alone repeater hub
	XGL-FMEA	Fnet, Master
BACnet/IP	XGL-BIPT	BACnet client/server



Features

XGK Series

- Fastest CPU processing of 8.5ns/step
- Up to 6,144 I/O points configurable (32,768 points controllable with remote I/O)
- Integrated intelligent software package : XG5000, XG-PD, XG-PM
- System solution based on open network : Ethernet, Profibus-DP, DeviceNet
- Special devices for easy programming
- Massive device memory
- USB I/F for programming up/download & monitoring

XGI Series

- Fastest CPU processing of 8.5ns/step
- Up to 6,144 I/O points configurable (131,072 points controllable with remote I/O)
- IEC 61131-3 standard programming
 - LD (Ladder diagram), SFC (Sequential function chart), ST (Structured text)
 - User defined FB (Function block)
- Built-in PID function (Max. 256 loop)
- USB I/F for programming up/download & monitoring

Modules

CPU Modules

High-Speed and Large Scale Control

XGK-CPUUN (XGI-CPUUN)

- Built-in Ethernet port
- 256K (2MB) program memory
- 8.5ns processing speed
- 6,144 I/O points control

XGK-CPUU (XGI-CPUU)

- 128K (1MB) program memory
- 28ns processing speed
- 6,144 I/O points control

XGK-CPUHN

- Built-in Ethernet port
- 128K (1MB) program memory
- 8.5ns processing speed
- 6,144 I/O points control

XGK-CPUH (XGI-CPUH)

- 64K (512KB) program memory
- 28ns processing speed
- 6,144 I/O points control

XGK-CPUSN

- Built-in Ethernet port
- 64K (512KB) program memory
- 8.5ns processing speed
- 3,072 I/O points control

XGK-CPUA

- 32K program memory
- 28ns processing speed
- 3,072 I/O points control

General Sequence Control

XGK-CPUS (XGI-CPUS)

- 32K (128KB) program memory
- 84ns processing speed
- 3,072 I/O points control

XGK-CPUE (XGI-CPUE)

- 16K (64KB) program memory
- 84ns processing speed
- 1,536 I/O points control

Expansion Modules

Power Modules

With AC free voltage, 220V and DC 24 V power supply

Base Modules

With 4/6/8/12 main and expansion base

Digital Input /Output Modules

From 8 to 64 of transistor, Relay and triac switches

Analog Input /Output Modules

With 4 or 8 ch current/Voltage signals

Temperature Input Modules

With 4 ch Pt100/JPt100 resistance thermometer and thermocouple

High Speed Counter Module

For connection with incremental encoder (2 channels of open collector or line driver type)

Motion/Positioning module

EtherCAT based motion / positioning for servo and motor (1~32 axes)

Network Modules

Fast Ethernet Modules

Ethernet Network with TCP/IP protocol

Profibus-DP Modules

Profibus-DP fieldbus protocol for connection between LS PLC and different manufacturers

DeviceNet Modules

DeviceNet fieldbus protocol for connection between LS PLC and different manufacturers

Rnet Modules

Dedicated network for remote I/O control (LS Smart I/O)

Cnet Module

Serial communication module with RS-232C/422/485

RAPiEnet Module

Dedicated network based on Ethernet

System Composition

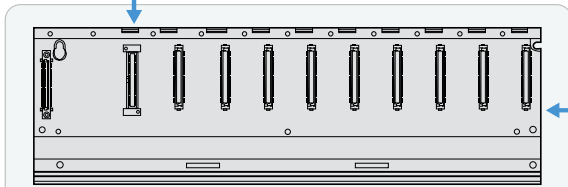
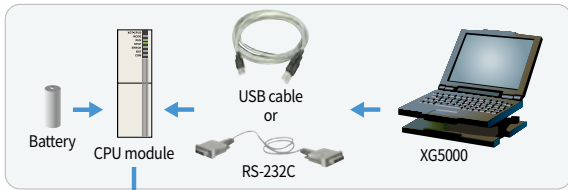

Main base (XGB-M□□A)



Expansion cable (XGC-E□□□)

Item	Type	Description	
Expansion Cable	XGC-E041	Expansion cable 0.4m	
	XGC-E061	Expansion cable 0.6m	
	XGC-E121	Expansion cable 1.2m	
	XGC-E301	Expansion cable 3.0m	
	XGC-E501	Expansion cable 5.0m	
	XGC-E102	Expansion cable 10m	
	XGC-E152	Expansion cable 15m	
	XGT-TERA	Expansion terminator	
	Expansion Terminator		

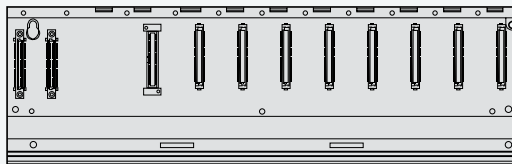

Expansion base (XGB-E□□A)

Item	Main Base	Expansion Base
4 slot	XGB-M04A	XGB-E04A
6 slot	XGB-M06A	XGB-E06A
8 slot	XGB-M08A	XGB-E08A
10 slot	XGB-M10A	-
12 slot	XGB-M12A	XGB-E12A

XG5000 Cable (RS-232C)

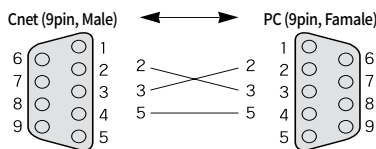

	CPU Module	I/O Point
XGK	XGK-CPUH, CPUU, CPUHN, CPUUN	6,144
	XGK-CPUS, CPUA, CPUSN	3,072
	XGK-CPUE	1,536
XGI	XGI-CPUUN, CPUU/D, CPUU, CPUH	6,144
	XGI-CPUS	3,072
	XGI-CPUE	1,536

CPU Connecting Cable	
USB 301A	USB downloading cable
K1C-050A	RS-232C downloading cable

Item	Type	Description
USB cable	USB-301A	USB downloading cable
RS-232C cable	K1C-050A	RS-232C downloading cable

Item	Input Module		
	AC110V	AC220V	DC24V
8 points	-	XGI-A21A	XGI-D21A
16 points	XGI-A12A	-	XGI-D22A
	-	XGI-D22B	-
32 points	-	-	XGI-D24A
	-	-	XGI-D24B
64 points	-	-	XGI-D28A
	-	-	XGI-D28B



Power module (XGP-□□□□)

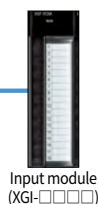

Input module (XGI-□□□□)



Output module (XGQ-□□□□)



Special module (XGF-□□□□)

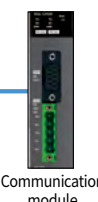

Communication module (XGL-□□□□)

Power Module			
AC	Free Voltage	XGP-ACF1	DC5V 3A DC24V 0.6A
		XGP-ACF2	DC5V 6A
	220V	XGP-AC23	DC5V 8.5A
DC		XGP-DC42	DC5V 6A

Item	Output Module		
	Relay	Triac	Transistor
8 points	XGQ-RY1A	-	XGQ-TR1C
16 points	XGQ-RY2A	XGQ-SS2A	XGQ-TR2A
	XGQ-RY2B	-	XGQ-TR2B
32 points	-	-	XGQ-TR4A
	-	-	XGQ-TR4B
64 points	-	-	XGQ-TR8A
	-	-	XGQ-TR8B

Item	Special Module	
Analog Input	XGF-AV8A	Voltage input type, 8ch
	XGF-AC8A	Current input type, 8ch
	XGF-AD8A	Voltage/Current input, 8ch
	XGF-AD4S	Voltage/Current input, 4ch (Isolated)
	XGF-AD16A	Voltage/Current input, 16ch
Analog Output	XGF-AW4S	2-Wire, Voltage/Current input, 4ch (Isolated)
	XGF-DV4A	Voltage output type, 4ch
	XGF-DC4A	Current output type, 4ch
	XGF-DV8A	Voltage output type, 8ch
	XGF-DC8A	Current output type, 8ch
Analog Input/Output	XGF-DV4S	Voltage output, 4ch (Isolated)
	XGF-DC4S	Current output, 4ch (Isolated)
High-Speed Counter	XGF-DA4S	Voltage/Current output, 4ch (Isolated)
	XGF-AH6A	Input: 4ch, Voltage/Current Output: 2ch voltage/Current
Positioning	XGF-HO2A	Pulse (OC) input type, 2ch
	XGF-HD2A	Pulse (LD) input type, 2ch
Positioning (Network Type)	XGF-PO1H-PO4H	Open collector, 1-4axes
	XGF-PD1H-PD4H	Line drive, 1-4axes
Motion Module	XGF-PN8A	LS Standard EtherCAT Net. 8axes
	XGF-PN8B	Standard EtherCAT Net. 8axes
Temperature Control	XGF-M32E	Standard EtherCAT 32axes
	XGF-TC4S	Thermocouple input, 4ch
Temperature Controller	XGF-RD4A	RTD input, 4ch
	XGF-RD4S	RTD Input, 4ch (Insulated)
Event Input	XGF-TC4UD	Input: 4ch, (Voltage/Current, RTD/TC) Output: 8ch, (TR/Current)
	XGF-TC4RT	Controller: 4 loops Input: 4ch, (RTD) Output: 4ch, (TR) Controller: 4 loops
Data Log	XGF-SOEA	DC24V, 32points
	XGF-DL16A	USB2.0, CF2001, Max16Gbyte, 32 points 1 slot (Input 22 points, Output 10 points)

Item	Communication Module	
RAPIEnet+ - RAPIEnet v2 - EtherNet/IP - Modbus TCP/IP - Dedicated XGT Network	XGL-EOPCT	OPC UA, Twisted fair 2Ch
	XGL-EFMTB	Master/Client, Twisted fair 2ch.
	XGL-EFMFB	Master/Client, Fiber optic 2ch.
	XGL-EFMHB	Master/Client, Twisted fair/fiber optic
	XGL-DBDT	Expansion driver - Twisted pair 2ch.
	XGL-DBDF	Expansion driver - Fiber optic 2ch.
	XGL-DBDH	Expansion driver - Fiber optic / Twisted pair
	XOL-ES4T	Stand alone switch twisted pair 4ch.
	XOL-ES4H	Stand alone switch twisted 2ch. fiber 2ch.
	XGL-EH5T	Open Ethernet switching hub
Computer Link (Cnet)	XGL-CH2B	RS-232C 1ch., RS-422/485 1ch.
	XGL-C22B	RS-232C 2ch.
	XGL-C42B	RS-422/485 2ch.
DeviceNet (Dnet)	XGL-DMEB	DeviceNet, Master
	XGL-DSEB	DeviceNet, Slave
Profibus-DP (Pnet)	XGL-PMEB	Profibus-DP, Master
	XGL-PSRA	Profibus-DP Slave, Remote interface
Rnet	XGL-PSEA	Profibus-DP Slave
	XGL-RMEB	Rnet, Master, TP
Fnet	GOL-RR8T	Rnet stand alone repeater hub
	XGL-FMEA	Fnet, Master
BACnet/IP	XGL-BIPT	BACnet client/server
	XGL-EIMT	RAPIEnet, Twisted fair 2Ch
RAPIEnet v1	XGL-EIMF	RAPIEnet, Fiber optic 2Ch
	XGL-EIMH	RAPIEnet, Twisted fair, Fiber optic
EtherNet/IP	XGL-EIPT	Industrial Ethernet, Twisted fair 2Ch

PLC XGB Series | Compact and Block Type PLC



Features

XGB-U (XBC / XEC-U)

- Max. 60ns/step processing speed
- Max. 2 high speed backplane extension modules
- Max. 10 expansion modules
- Max. 352 I/O points
- 32Ksteps/384KB program capacity
- Line-up : Standard, Built-in analog, Built-in positioning
- * Built in Ethernet, SD card

XBC / XEC-U

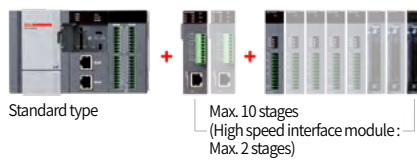

XBC / XEC-H

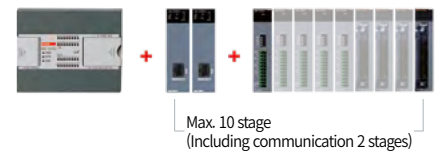

XBC / XEC-SU

- Max. 60ns/step processing speed
- Max. 7 expansion modules
- Max. 284 I/O points
- 15Ksteps/250KB program capacity

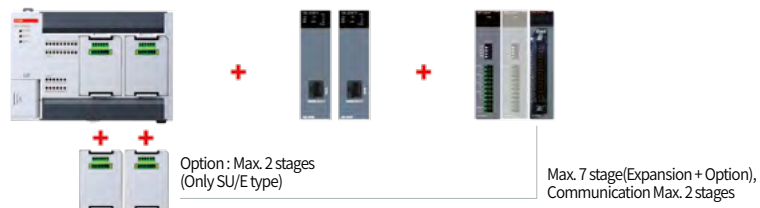

XBC / XEC-E

- Max. 240ns/step processing speed
- Max. 2 expansion modules
- Max. 38 I/O points
- 4Ksteps/50KB program capacity



Option Modules	
XBO-RTCA	RTC (Real time clock), Battery
XBO-DC04A	DC 24V, Input 4 points
XBO-TN04A	TR (Sink), Output 4 points
XBO-AD02A	Voltage/Current, Input 2ch
XBO-DA02A	Voltage/Current, Output 2ch
XBO-AH02A	Voltage/Current, Input 1ch / Voltage/Current, Output 1ch
XBO-RD01A	RTD (Resistance temperature detector), Input 1ch
XBO-TC02A	TC (Thermo couple), Input 2ch

XBM / XEM-H2, HP

- Max. 40ns/step instruction times
- 64Kstep built-in program memory
- Max. 256 I/O points
- Expandability : 7 cards (Compatible with all XGB cards)

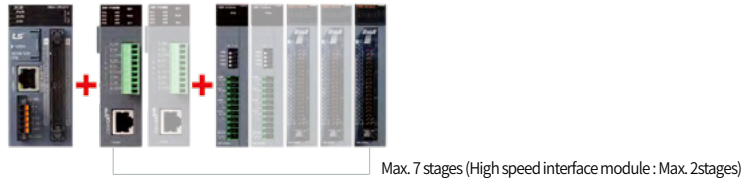

XBM-S

- Max. 160ns/step processing speed
- Max. 7 expansion modules
- Max. 256 I/O points
- 10Ksteps program capacity



Product List

Block Type Unit (U)	
Model	Specification
XBC/XEC-DN(P)32U	AC 110-220V, 16points DC24V input, 16points transistor sink(Source) type output
XBC/XEC-DR28U	AC 110-220V, 16points DC24V input, 12points relay output
XBC/XEC-DN(P)32UP	AC 110-220V, 16points DC24V input, 16points transistor sink(Source) type output, 4 axes built-in positioning
XBC/XEC-DR28UP	AC 110-220V, 16points DC24V input, 12points relay output, 4 axes built-in positioning
XBC/XEC-DN(P)32UA	AC 110-220V, DC24V input, 16points transistor sink(Source) type output, 8 channel built-in analog
XBC/XEC-DR28UA	AC 110-220V, DC24V input, 12points relay output, 8 channel built-in analog
XBC/XEC-DN(P)32U/DC	DC 24V, 16points DC24V input, 16points transistor sink(Source) type output
XBC/XEC-DR28U/DC	DC 24V, 16points DC24V input, 12points relay output
XBC/XEC-DN(P)32UP/DC	DC 24V, 16points DC24V input, 16points transistor sink(Source) type output, 4 axes built-in positioning
XBC/XEC-DR28UP/DC	DC 24V, 16points DC24V input, 12points relay output, 4 axes built-in positioning
XBC/XEC-DN(P)32UA/DC	DC 24V, DC24V input, 16points transistor sink(Source) type output, 8 channel built-in analog
XBC/XEC-DR28UA/DC	DC 24V, DC24V input, 12points relay output, 8 channel built-in analog

Block Type Unit (High Performance)	
XBC/XEC-DR32H	AC 100-240V, DC24 input 16 pts, Relay output 16 pts
XBC/XEC-DR64H	AC 100-240V, DC24 input 32 pts, Relay output 32 pts
XBC/XEC-DN32H	AC 100-240V, DC24 input 16 pts, Tr. output 16 pts (Sink)
XBC/XEC-DN64H	AC 100-240V, DC24 input 32 pts, Tr. output 32 pts (Sink)
XEC-DP32H	AC 100-240V, DC24 input 16 pts, Tr. output 16 pts (Source)
XEC-DP64H	AC 100-240V, DC24 input 32 pts, Tr. output 32 pts (Source)
XBC-DR32H/DC	DC 24V, DC24 input 16 pts, Relay output 16 pts
XBC-DR64H/DC	DC 24V, DC24 input 32 pts, Relay output 32 pts
XBC-DN32H/DC	DC 24V, DC24 input 16 pts, Tr. output 16 pts (Sink)
XBC-DN64H/DC	DC 24V, DC24 input 32 pts, Tr. output 32 pts (Sink)
XEC-DR32H/D1	DC 12/24V, DC12/24 input 16 pts, Relay output 16 pts
XEC-DR64H/D1	DC 12/24V, DC12/24 input 32 pts, Relay output 32 pts

Block Type Unit (Standard)	
XBC/XEC-DR20SU	AC 100 - 240, DC24V input 12 points, Relay output 8 points
XBC/XEC-DR30SU	AC 100 - 240, DC24V input 18 points, Relay output 12 points
XBC/XEC-DR40SU	AC 100 - 240, DC24V input 24 points, Relay output 16 points
XBC/XEC-DR60SU	AC 100 - 240, DC24V input 36 points, Relay output 24 points
XBC/XEC-DN20SU	AC 100 - 240, DC24V input 12 points, Transistor output 8 points (Sink)
XBC/XEC-DN30SU	AC 100 - 240, DC24V input 18 points, Transistor output 12 points (Sink)
XBC/XEC-DN40SU	AC 100 - 240, DC24V input 24 points, Transistor output 16 points (Sink)
XBC/XEC-DN60SU	AC 100 - 240, DC24V input 36 points, Transistor output 24 points (Sink)
XBC/XEC-DP20SU	AC 100 - 240, DC24V input 12 points, Transistor output 8 points (Source)
XBC/XEC-DP30SU	AC 100 - 240, DC24V input 18 points, Transistor output 12 points (Source)
XBC/XEC-DP40SU	AC 100 - 240, DC24V input 24 points, Transistor output 16 points (Source)
XBC/XEC-DP60SU	AC 100 - 240, DC24V input 36 points, Transistor output 24 points (Source)

Block Type Unit (Economic)	
XBC/XEC-DR10E	AC 100-240V, 6 pts DC input, 4 pts relay output
XBC/XEC-DR14E	AC 100-240V, 8 pts DC input, 6 pts relay output
XBC/XEC-DR20E	AC 100-240V, 12 pts DC input, 8 pts relay output
XBC/XEC-DR30E	AC 100-240V, 18 pts DC input, 12 pts relay output
XBC/XEC-DN10E	AC 100-240V, 6 pts DC input, 4 pts Tr. output (Sink)
XBC/XEC-DN14E	AC 100-240V, 8 pts DC input, 6 pts Tr. output (Sink)
XBC/XEC-DN20E	AC 100-240V, 12 pts DC input, 8 pts Tr. output (Sink)
XBC/XEC-DN30E	AC 100-240V, 18 pts DC input, 12 pts Tr. output (Sink)
XBC/XEC-DP10E	AC 100-240V, 6 pts DC input, 4 pts Tr. output (Source)
XBC/XEC-DP14E	AC 100-240V, 8 pts DC input, 6 pts Tr. output (Source)
XBC/XEC-DP20E	AC 100-240V, 12 pts DC input, 8 pts Tr. output (Source)
XBC/XEC-DP30E	AC 100-240V, 18 pts DC input, 12 pts Tr. output (Source)

Modular Type Unit	
XBM/XEM-DN32H2	DC24V, 16pts DC24V input, 16 pts TR output(Sink), 2 axes built-in positioning (XPM)
XBM/XEM-DN32HP	DC24V, 16pts DC24V input, 16 pts TR output(Sink), 6 axes built-in positioning (XPM)
XBM/XEM-DP32H2	DC24V, 16pts DC24V input, 16 pts TR output(Source), 2 axes built-in positioning (XPM)
XBM/XEM-DP32HP	DC24V, 16pts DC24V input, 16 pts TR output(Source), 6 axes built-in positioning (XPM)
XBM-DR16S	AC 100-240V, DC24 input 8 pts, Tr. output 8 pts (Sink)
XBM-DN16S	AC 100-240V, DC24 input 8 pts, Tr. output 8 pts (Source)
XBM-DN32S	AC 100-240V, DC24 input 16 pts, Tr. output 16 pts (Source)

Loader Cable	
PMC-310S	Connection cable (PC to PLC), 9pin (PC)-6pin (PLC)
USB-301A	Connection cable (PC to PLC), USB

Expansion I / O Module			
Model	Specification	Model	Specification
XBE-AC08A	8 pts AC110V input	XBE-TN08A	8 pts Tr. (Sink) output
XBE-DC08A	8 pts DC 24V input	XBE-TN16A	16 pts Tr. (Sink) output
XBE-DC16A	16 pts DC 12/24V input	XBE-TN32A	32 pts Tr. (Sink) output
XBE-DC16B	16 pts DC 24V input	XBE-TP08A	8 pts Tr. (Source) output
XBE-DC32A	32 pts DC 24V input	XBE-TP16A	16 pts Tr. (Source) output
XBE-RY08A	8 pts relay output	XBE-TP32A	32 pts Tr. (Source) output
XBE-RY08B	8 pts relay output	XBE-DR16A	8 pts DC 24V input, 8pts relay output
XBE-RY16A	16 pts relay output	XBE-DN32A	16 pts DC24V input, 16 pts TR output

Special Module	
XBF-AD04A	4ch analog input (Current/Voltage)
XBF-AD04C	4ch analog input (Current/Voltage, Resolution : 1/16000)
XBF-AH04A	2ch analog input (Current/Voltage)/2ch analog output (Current/Voltage)
XBF-DV04A	4ch analog output (Voltage)
XBF-DV04C	4ch analog input (Voltage, Resolution : 1/16000)
XBF-DC04A	4ch analog output (Current)
XBF-DC04C	4ch analog input (Current, Resolution : 1/16000)
XBF-RD04A	4ch RTD input
XBF-TC04S	4ch thermocouple input
XBF-TC04TT	Temperature controller, Thermocouple
XBF-TC04RT	Temperature controller, RTD
XBF-PD02A	Line drive 2axes
XBF-PN08B	EtherCAT positioning module, 8axes
XBF-PN04B	Standard EtherCAT network, 4axis
XBF-AD08A	8Ch analog input (Current/Voltage)
XBF-HO02A	2ch high-speed counter input (Open collector)
XBF-HD02A	2ch high-speed counter input (Line drive)

Communication Module	
XBL-C41A	Cnet (RS-422/485), 1ch
XBL-C21A	Cnet (RS-232C), 1ch
XBL-EMTA	Fast Ethernet (100Mbps), 1ch
XBL-EIPT	Ethernet/IP, 2ch
XBL-EIMT	RAPiEnet, Twisted pair 2ch, 100Mbps
XBL-EIMF	RAPiEnet I/F, Max. 2km (Fiber 2ch.), 100Mbps
XBL-EIMH	RAPiEnet I/F (Twisted pair 1ch, Fiber 1ch.), 100Mbps
XBL-PMEC	Profibus-DP, Master, RS-485
XBL-PSEA	Profibus-DP, Slave, RS-485
XBL-DSEA	DeviceNet, Slave
XBL-RMEA	Rnet, Master
XBL-CMEA	CANopen (10, 20, 50, 100, 125, 250, 500, 800, 1000Kbps, Num of PDO : 32)
XBL-CSEA	CANopen (10, 20, 50, 100, 125, 250, 500, 800, 1000Kbps, Num of PDO : 64)

Option Module	
XBO-AD02A	Voltage/Current, Input 2ch
XBO-DA02A	Voltage/Current, Output 2ch
XBO-AH02A	Voltage/Current, Input 1ch, Voltage/Current, Output 1ch
XBO-TC02A	TC (Thermo couple), Input 2ch
XBO-RTCA	RTC (Real time clock), Battery
XBO-DC04A	DC 24V, Input 4pts
XBO-TN04A	TR (Sink), Output 4 pts
XBO-RD01A	RTD (Resistance temperature detector), Input 1ch

Connection Cable	XBF-PD02A	XBF-HD02A	XBF-HD02A	XBE-DC32A	XBE-TN32A	XBE-TP32S	XBM-DN16S	XBM-DN32S	XBM/XEM-H2 HP	XBB-UP	Cable length
R40H/20HH-05S-XBM3							●	●			0.5m
R40H/20HH-10S-XBM3							●	●			1m
C40HH-05SB-XBI	●	●	●	●	●	●			●	●	0.5m
C40HH-10SB-XBI	●	●	●	●	●	●			●	●	1m
C40HH-15SB-XBI	●	●	●	●	●	●			●	●	1.5m
C40HH-30SB-XBI	●	●	●	●	●	●			●	●	3m
C40HH-05SB-XBE					●	●					0.5m
C40HH-10SB-XBE					●	●					1m
C40HH-15SB-XBE					●	●					1.5m
C40HH-20SB-XBE					●	●					2m
C40HH-30SB-XBE					●	●					3m
C40HH-05SB-XBE					●						0.5m
C40HH-10SB-XBE					●						1m
C40HH-15SB-XBE					●						1.5m
C40HH-20SB-XBE					●						2m
C40HH-30SB-XBE					●						3m

Smart I/O Block Type | RAPIEnet+

RAPIEnet · EtherNet/IP · Modbus TCP/IP



Special Features

- Support for modbus TCP/IP, RAPIEnet, and Ethernet/IP protocols
- connector : RJ45
- Ring, Line topology support can help you configure a network suitable for the site.
 - Redundancy support when configuring ring topology
- No IP setup required, simple module setup with just a local number setting.
- Simplify parameter settings : Add modules and check boxes via auto scan possible to set parameters through (No program written)
- Fast data processing
- Reduce cable and connector costs compared to fieldbus based on serial communication
- Provides a variety of diagnostic services
 - Error indication in case of a local conflict in the network
 - Provides network-based O/S upgrades: Remote O/S download is available via master module
 - CRC error flag information can be provided to check the status of communication tracks in the network.
 - Enhanced auto-scan capability : Stations conflict indication, Providing module information
 - Provide error flag in case of communication error master ↔ Smart I/O

Specification

Contents		Description
Transmission Specification	Transmission Speed	PORT1, 2 : 100Mbps
	Transmission Type	Base band
	Max Distance Between Nods	100M
	Transmission Media	Category 5e STP (Shielded twisted-pair) cable
	Max Protocol Size	1,500 bytes
	Communication Access Method	CSMA/CD
	Frame Error Checking Way	CRC32
Max Load	Ethernet : 10,000pps, RAPIEnet : 40,000pps	
Topology	Line, Tree, Star, Ring (Available on RAPIEnet only)	
Diagnose Function	Local/IP conflict detection, Self-diagnosis service, Diagnosis by XG5000	
Station/IP Setting Method	Rotary switch, XG5000, BOOTP/DHCP	
Station/IP Setting Range	Station : Rotary switch (1 ~ 99) IP : 192.168.1.xx (xx : 100 + rotary switch 1~99)	
LED Status	STATUS, PORT1, PORT2, LACTH (Only output)	
Parameter Setting	XG5000 (Ethernet)	
Device File	EDS file (Available for EtherNet/IP only)	
Protocol	RAPIEnet, EtherNet/IP, Modbus TCP/IP, BOOTP, DHCP (RAPIEnet, EtherNet/IP enables XGL-EFMxB and smart extension)	
Input & Output Refresh Size	Max input refresh size	64 bytes
	Max output refresh size	64 bytes

Contents		GEL-D24C	GEL-DT4C1	GEL-TR4C1	GEL-RY2C
Digital I/O	Points	32(Input)	16/16(In/Out)	32(Output)	16(Output)
	Rated Input Current	5mA		-	-
	Rated Load Voltage	-	DC 24V		DC24V/AC220V, 2A/point, 5A/COM
	Max. Load Current	-	0.5A/point, 3A/COM		AC250V, DC110V, 1,200times/hour
	ON Voltage	DC 19V or higher		-	Min. switching load: DC 5V/1mA
	OFF Voltage	DC 6V or less		-	
	Insulation Method	Photo coupler insulation			
Contents		GEL-AV8C	GEL-AC8C	GEL-DV4C	GEL-DC4C
Analog I/O	Channels	8		4	
	Input/Output Type	Voltage	Current	Voltage	Current
	Input/Output Range	DC 1-5V, 0-5V, 0-10V, -10-10V	0~20 mA, 4~20 mA	DC 1-5V, 0-5V, 0-10V, -10-10V	0~20 mA, 4~20 mA
	Accuracy	0.3% (Ambient air temperature 0 ~ 55°C)			
	Max. Resolution	1/16,000			
	Max. Conversion Rate	10ms / Channels			
	Insulation Method	Insulation between input / Output terminal and PLC power (No insulation between channels)			

Smart I/O Expansion | RAPIEnet+

RAPIEnet · EtherNet/IP · Modbus TCP/IP



Special Features

- Possible for PLC system of extended smart I/O adapter XEL-BSSRx with extended digital, Analog I/O of XGB series.
 - XGB extension I/O available number : 8
- Support for modbus TCP/IP, RAPIEnet, and OtherNet/IP protocols
- Supports 1Gbps maximum media speed for electric, Optical and mixed modules
- 2 port media support for each electric, Optical and mixed module
 - Support for ring and line topology configuration via relay function without additional switches
- One line can be operated without error when extending ring structure.
- Provide service-status diagnostics

Specification

Item		XEL-BSSRT	XEL-BSSRF	XEL-BSSRH
Transmission Specifications	Transmission Speed (Mbps)	100/1000	100/1000	Electric : 100/1000 Optical : 100/1000
	Transmission Method	Base band		
	Maximum Distance Between Nodes	100m@CAT5E or higher	2km@100Mbps.MM	Electric : 100m Optical : 2km
	Send Media	Electric : Category 5E or higher STP (Shielded twisted-pair) cable Optical : Multi mode(MMF)/Single mode(SMF) cable		
	Maximum Protocol Size	1,500 bytes		
	Communication Network Access Method	CSMA/CD		
	Frame Error Check Method	CRC32		
Max. Load	Ethernet : 10,000pps, RAPIEnet : 40,000pps			
Topology	When using RAPIEnet : Lines, Ring (Using MRS if you use a different topology) When not using RAPIEnet : Line, Tree, Star etc. (with switch)			
Diagnose Function	Station number / IP collision detection function, Self-diagnosis service, Diagnosis using XG5000			
Station number / IP setting method	Rotary switch, XG5000, BOOTP/DHCP			
Station number / IP setting range	Station number : Rotary switch (1 ~ 99) IP : 192.168.1.xx (xx:100 + rotary switch 1~99)			
External Connecting Terminal	USB mini B : PADT connection RJ45, SFP : PADT connection, Data communication 3pin push in/Screw fixed type connector : Power input			
Status Indication LED	RUN, RMS, RNS, RELAY, LINK/ACT1, LINK/ACT2 6 types			
Parameter Setting	XG5000 (USB, Ethernet)			
Device File	EDS file (Only EtherNet/IP)			
Maximum Number of Modules to be Installed	8ea			
Protocol	RAPIEnet, EtherNet/IP, Modbus-TCP, BOOTP, DHCP (RAPIEnet, EtherNet / IP can be Smart extension with XGL-EFMxB)			

Available XGB I/O Module

Item		Module
Digital	Input	XBE-DC08A
		XBE-DC16A/B
		XBE-DC32A
	Output	XBE-AC08A
		XBE-TN/TP08A
		XBE-TN/TP16A
Input/Output	XBE-TN/TP32A	
	XBE-RY08A/B	
	XBE-RY16A	
	XBE-DR16A	
Analog	Input	XBE-DN32A
		XBF-AD04A
		XBF-AD08A
		XBF-AD04C
	Output	XBF-DV04A
		XBF-DC04A
		XBF-DC04B
		XBF-DV04C
	Input/Output	XBF-DC04C
		XBF-AH04A
		XBF-RD04A
		XBF-RD01A
		XBF-TC04B
		XBF-TC04S
Load Cell	XBF-LD02S	
	XBF-HO02A	
High-speed Counter	XBF-HD02A	
	XBF-HD02A	

Smart I/O Stand Alone Type



Features

- Wiring reduction and real time control of distributed I/O
- Supporting Rnet, DeviceNet, Profibus-DP, MODBUS (RS-422/485), RAPIEnet (RJ-45)
- Various I/O (DC/TR/Relay) modules with the unit of 16/32 points

Digital I/O Specifications

Item	Input		Output			Mixed Module	
	DC (Sink / Source)		Transistor (Source: C type, Sink: C1 type)		Relay	DC (Sink / Source)	Transistor (Sink)
No. of Point	16	32	16	32	16	16	16
Rated Input (Load Voltage)	DC 24V		DC 24V		DC 24V/AC, 110V/220V	DC 24V	
Input Current (Load Current)	7mA		0.1A / 2A, 0.5A / 3A		2A/5A	0.1A / 2A, 0.5A / 3A	
Response Time	Off → On	3ms or less	3ms or less		3ms or less	3ms or less	
	On → Off	3ms or less	3ms or less		3ms or less	3ms or less	
Common	16 points / COM		16 points / COM		16 points / COM	16 points / COM	
Current Consumption	200 mA	300 mA	200 mA	300 mA	550 mA	200 mA	300 mA
Network	Rnet	GRL-D22C	GRL-D24C	GRL-TR2C/C1	GRL-TR4C/C1	GRL-RY2C	GRL-DT4C/C1
	Profibus-DP	GPL-D22C	GPL-D24C	GPL-TR2C/C1	GPL-TR4C/C1	GPL-RY2C	GPL-DT4C/C1
	DeviceNet	GDL-D22C	GDL-D24C	GDL-TR2C/C1	GDL-TR4C/C1	GDL-RY2C	GDL-DT4C/C1
	Modbus	GSL-D22C	GSL-D24C	GSL-TR2C/C1	GSL-TR4C/C1	GSL-RY2C	GSL-DT4C/C1

Analog I/O Specifications

Item	GPL-AV8C / GEL-AV8C	GPL-AC8C / GEL-AC8C	Item	GPL-DV4C / GEL-DV4C	GPL-DC4C / GEL-DC4C
Input Channels	8 channels		Output Channels	4 channels	
Analog Input	DC1~5V, 0~5V, 0~10V	0~20 mA, 4~20 mA	Digital Input	0~4000, 0~8000, -8000~8000	0~8000
	-10~+10V	-20~20 mA	Analog Output	DC1~5V, 0~5V, 0~10V	0~20 mA, 4~20 mA
Digital Output	0~4000, 0~8000, -8000~8000	0~4000, -8000~8000	Load Impedance	-10~+10V	
Input Impedance	1MΩ	250 Ω		1KΩ or more (0~5V or 1~5V)	
Max. Resolution	±15V	±30 mA	Resolution	2KΩ or more (0~10V or -10~10V)	500 Ω or less
	1.25 mV	2.5 μA		1.25 mV	2.5 μA
Accuracy	±0.3% (Full scale, Ta=0~55°C)	±0.3% (Full scale, Ta=23°C±5°C)	Accuracy	±0.3% (Full scale, Ta=0~55°C)	±0.3% (Full scale, Ta=23°C±5°C)
	GRL-D22C	±0.4% (Full scale, Ta=0~55°C)			±0.4% (Full scale, Ta=0~55°C)
Conversion Speed	10 ms or less/8 channel		Conversion Speed	10 ms or less/4 channel	
Response Period	10 ms or less/8 channels + transmission period (ms)		Response Period	10 ms or less / 8 channels + transmission period (Ms)	
	Analog input/output terminal with FG → Insulation			Analog input/output terminal with FG → insulation	
Insulation Method	Analog input/output terminal with communication terminal → Insulation		Insulation Method	Analog input/output terminal with communication terminal → Insulation	
	Analog input/output terminal with each channel → No insulation			Analog input/output terminal with each channel → No insulation	
External Power Supply	DC 24V (21.6 ~ 26.4)		External Power Supply	DC 24V (20.4 ~ 28.8)	
External Current Consumption	DC 24V : 220mA		External Current Consumption	210 mA	240 mA
Weight (kg)	0.313	0.313	Weight (kg)	0.314	0.322

Communication Specifications

Item	Rnet (LS Dedicated Network)	Profibus-DP	DeviceNet	MODBUS
Protocol	LS dedicated protocol (Fnet for remote)	Profibus-DP (RS-485/EN50170)	DeviceNet (CAN)	MODBUS (RS-422/485)
Transmission Speed	1 mbps	9.6 Kbps ~ 12 Mbps	125/250/500 Kbps	2.4 Kbps ~ 38.4 Kbps
Transmission Distance	750 m/segment	100m~1.2km	500/250/125 m (Thin cable: 100 m)	500 m
Topology	Bus token	Bus	Trunk & drop	Bus
Transmission	Pass & broadcast	Token pass & master/slave (Poll)	CSMA/NBA (Poll, Cyclic, COS, Bit strobe)	Master/Slave (Poll)
No. of Stations	32/segment (Input : 32, Output : 32)	32/segment, 99/network	64	32

Smart I/O Expandable Type



Modbus TCP, EtherNet/IP, DeviceNet, Profibus-DP

Features

- IEEE 802.3 standard
- Modbus TCP/IP, EtherNet/IP
- 10/100BASE-TX media
- Ethernet twisted pair 2 ports (RJ-45)
- 2 channels Ethernet MAC
- Auto-negotiation/Auto-crossover
- Various system configuration

Available Module

In/Out	Part Number	XDL-BSSA	XPL-BSSA	XEL-BSSA	XEL-BSSB	XRL-BSSA	XEL-BSSCT
DC Input	XBE-DC08A	○	○	○	○	○	○
	XBE-DC16A(B)	○	○	○	○	○	○
	XBE-DC32A	○	○	○	○	○	○
AC Input	XBE-AC08A	X	○	○	○	○	○
Relay Output	XBE-RY08A(B)	○	○	○	○	○	○
	XBE-RY16A	○	○	○	○	○	○
TR Output	XBE-TN(TP)08A	○	○	○	○	○	○
	XBE-TN(TP)16A	○	○	○	○	○	○
	XBE-TN(TP)32A	○	○	○	○	○	○
Mixed	XBE-DR16A	○	○	○	○	○	○
	XBE-DN32A	X	X	○	○	X	○
AD	XBF-AD04A	○	○	○	○	○	○
	XBF-AD08A	X	○	○	○	○	○
	XBF-AD04C	X	○	○	○	○	○
DA(I)	XBF-DC04A	○	○	○	○	○	○
	XBF-DC04C	X	○	○	○	○	○
DA(V)	XBF-DV04A	○	○	○	○	○	○
	XBF-DV04C	X	○	○	○	○	○
Mixed	XBF-AH04A	○	○	○	○	○	○
RTD	XBF-RD04A	○	○	○	○	○	○
TC	XBF-TC04S	○	○	○	○	○	○
Loadcell	XBF-LD02S	X	X	X	X	X	○
HSC	XBF-HO2A	X	X	X	X	X	○
	XBF-HD2A	X	X	X	X	X	○

DeviceNet Specification

Item	Specification	
Communication Interface	Poll, Bit-strobe, COS/cyclic	
	Group 2 only slave	
	Auto baud rate	
Master/Slave	Slave	
Max. Station	64 (Including master)	
Max. No. of Extension I/O Equipment	8	
Max. Digital I/O Point	512 point (Input max 256 point/output max 256 point)	
Max. No. of Analog I/O Channel	Input 16 channels (Output 16 channels)	
Cable	125kbps	
	250kbps	
Communication Speed & Distance	500m	
	250m	
	100m	
Input Power	DC 24V	
	Rated Input Voltage	19.2V ~ 28.8V (Available to operate in 11V)
	Power Range	5V(±20%)/1.5A
	Output Voltage/Current	Speed (Kbps)
Insulation	Distance (m)	
	Weight (g)	100

Modbus TCP, EtherNet / IP Specification

Item	Specification	
Communication Speed	10/100Mbps	
Transmission Path Method	Base band	
Standard Functions	IEEE 802.3	
Flow Control	HALF/FULL	
Modulation Type	NRZI	
Max. Distance Between Nodes	100m	
Max. Protocol Size	Data 1500byte	
Communication Zone Access Method	CSMA/CD	
Check Method for Frame Error	CRC32	
Connector Connection	RJ-45(2Port)	
IP Setting	S/W setting	
Topology	Bus, Star	
Protocol	MODBUS/TCP, EtherNet/IP	
Max. Digital I/O Point	512 (Input 256, Output 256)	
Max. Digital I/O Connection Number	8	
Max. Analog I/O Connection Number	8	
Expansion Analog Module Occupation Number	8byte	
Power	Rated Input Voltage/Current	DC 24V/0.7A
	Power Range	DC 19.2V ~ 28.8V
	Output Voltage/Current	5V(±20%)/1.5A
	Insulation	Non-insulation
Weight(g)	100	

Profibus-DP Specification

Item	Specification					
Standard	EN50170 / DIN 19245					
Interface	RS-485					
Medium Access	Polling					
Topology	Bus					
Encoding Method	NRZ					
Communication Interface	Sink mode, Freeze mode					
	Auto baud rate					
Master/Slave	Slave					
Cable	Shielded twisted pair					
Communication Speed and Distance	Speed (Kbps)	9.6	19.2	93.75	187.5	500
	Distance (m)	1200	1200	1200	1000	400
	Speed (Kbps)	1500	3000	6000	12000	-
	Distance (m)	200	100	100	100	-
Max. Node	100 station (Setting range: 0 ~ 99)					
Max. Modular Type I/O Equipment No.	8					
Max. Digital I/O Point	512point (Input Max.256point/output max.256point)					
Max. Analog I/O Channel No.	32 channels (Input Max. 16 channels/output Max. 16 channels) (Analog module occupy Digital 64 point)					
Input Power	Rated Input Voltage/Current	DC 24V/0.55A				
	Power Range	DC19.2 ~ 28.8V				
	Output Voltage/Current	5V(±20%) / 1.5A				
	Insulation	Non-insulation, Communication part insulation				
Weight (g)	100					

EtherCAT Smart I/O XEL-BSSCT

EtherCAT-Based connectivity



System Configuration

Connectivity with EtherCAT master (XMC-E32A/16A/08A/E32C) offers a total motion solution with devices such as sensors and analog modules

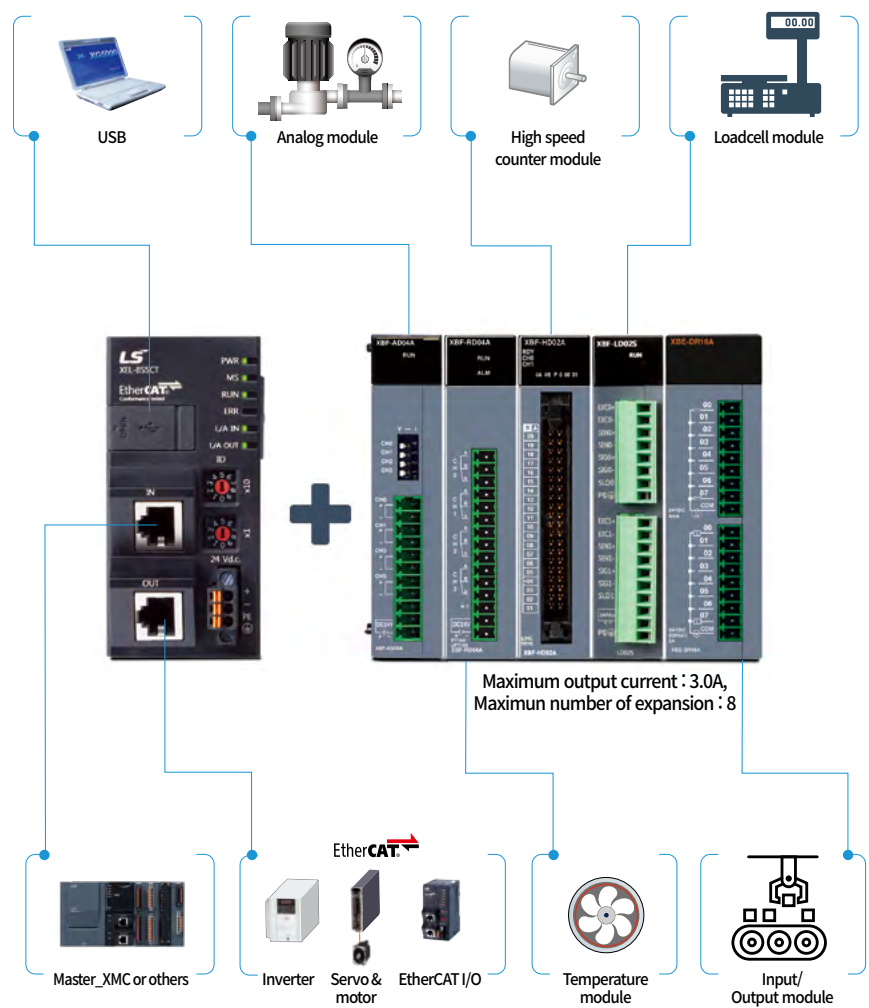

Performance Specification

Classification	Item		Specification	
Performance Specification of Adapter	Maximum Number of Expansion		8	
	Operation Mode		RUN, STOP (The test operation through the XG5000 is only available in STOP mode.)	
	Refresh Time		DC sync0 time x refresh time (0 ~ 100)	
	Standard Input Filter		1, 3, 5, 10, 20, 70, 100ms	
	Self-Diagnosis Function		Indication of a current error and warning	
	EEPROM	Self-Recovery Function		Enable/disable automatic recovery
		EEPROM Size		4 KB
	Memory	System Flag Area	F	2 KB
		Extension Module Mapping area	I	2 KB
			Q	2 KB
			U	1 KB
	External Connection Terminal	Programming Port		USB 1 channel
		Communication Port		RJ45 2 ports (Response to shield)
Power Port		3-Pin push-in/screw fixing type connector		
Status Indicator LED		6 types including PWR, MS, RUN, ERR, IN and OUT		
Communication Specification of EtherCAT	Maximum Number of Expansion Modules to be Mounted		8 modules	
	Communication Protocol		EtherCAT	
	Data Transfer Speed		100mbps	
	Physical Layer		100BASE-TX (IEEE 802.3)	
	Topology		Conforms to the specification of EtherCAT master.	
	Transmission Media		STP (Shielded twisted-pair) Cable with category 5 or higher	
	Transmission Distance		100m or less between the nodes	
	Size of PDO Data for Transmission and Reception		Input : Up to 1,024 byte, Output : Up to 1,024 byte	
	Size of Mailbox Data		Input : Up to 256 byte, Output : Up to 256 byte	
	Mailbox Support Command		SDO requests, SDO information	
	Refresh Method		Free-run, Refresh sync mode (For LS ELECTRIC Co., Ltd. only)	
	Node Address Setting Method		Rotary switch, Master, PADT	
	Node Address Setting Range			Explicit ID(1 ~ 99)
				Alias address(1 ~ 65535)
		Applies the EEPROM value set by the master when setting PADT 0		

Power Specification

	Item	Specification	Condition
Input	Rated Input Voltage	DC24V	
	Input Voltage Range	DC20.4 ~ 28.8V (-15%, +20%)	Within -15% and +20% of the rated input
	Input Current	Less than 1.3A (Typ.1A)	Input +DC28.8V, Maximum load
	Inrush Current	50A peak or less	Input +DC28.8V, Maximum load
	Efficiency	80 % or more	Input +DC28.8V, Maximum load
	Permitted Instantaneous Interruption	Within 10 ms	Input +DC28.8V, Maximum load
Output	Rated Output Voltage	DC5V (±2%)	
	Output Current	3.0A	
Indication of Voltage Status		LED on when the output voltage is normal	
Cable Specification		22 ~ 20 AWG (0.3 ~ 0.5mm2)	

Motion Controller

XMC-E32A/E16A/E08A/E32C

EtherCAT-Based motion control system ensures efficient system environment



Features



Professional

- CAM control :
Up to 32 CAM profiles (32,768 points/32 CAM profiles)
- Supports G-code
- Robot control :
Delta3, Delta3R, Linear delta and Etc.



Productivity

- High-speed program processing :
6.25ns (Basic command)
- EtherCAT-based high speed cycle times : 0.5/1/2/4ms (Same as main task's cycle time)
- Built-in digital and analog IO



Convenience

- XG5000 software for programming and monitoring
 - Sole, Integrated architecture for programming, Diagnosing and simulating for both motion controller and PLC
 - IEC standard motion function blocks
- SD card slot (SD card not included)
- Saving and executing programs, Data logging



Efficiency

- Integration with a variety of EtherCAT devices
 - Servo drive (Up to 32 axes), Remote I/O (Up to 32 I/Os), AC drives, Robots and Etc.
- Various built-in functions
 - 8 digital inputs / 16 digital outputs, Encoder inputs (2 ch), Ethernet analog input (2 ch)/ Output (2 ch)_E32A, RS-232C/ RS-485_E32C

System Configuration

Motion controller delivers an optimized solution to a system that has a need for motion control. With 8 digital inputs / 16 outputs, 2 analog inputs / Output (XMC-E32A/E16A/E08A only), 2 encoder inputs, RS-232C/RS-485(XMC-E32C only), and EtherCAT devices (Servo drive, INV, EtherCAT I/O, Robot), all can be connected rapidly and easily.

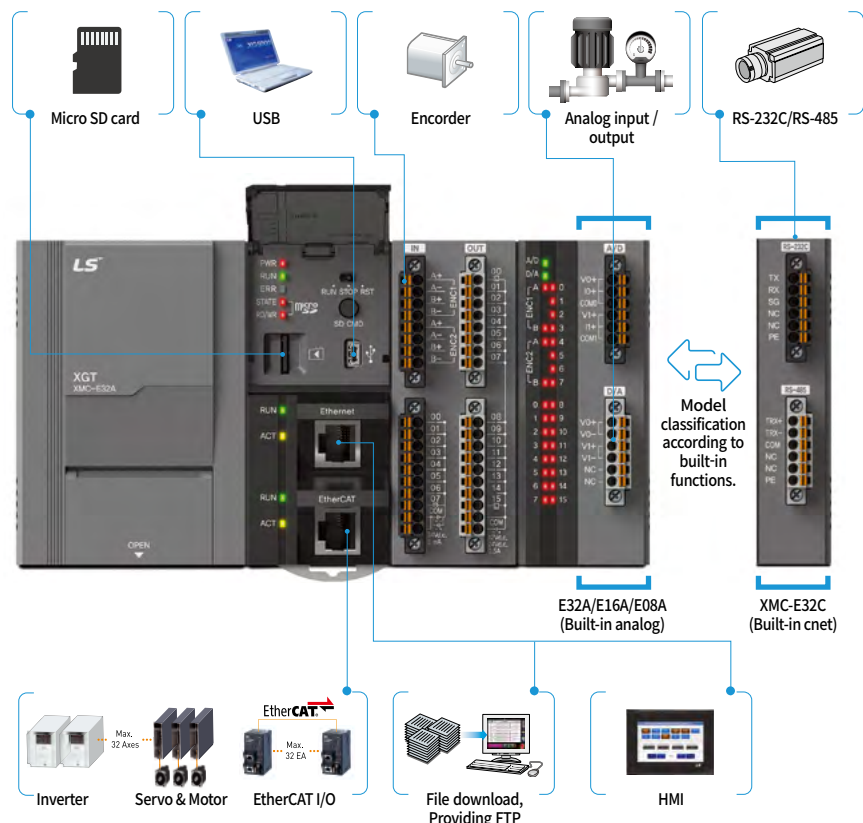

* Refer to page 8 (Performance specification) for supported axis information.

Power Specification

Item		Specification	
Operation method		Main task/Periodic task: Fixed cyclic operation, repetitive operation. v, Initial task: Only once at the time of entering the RUN	
Control period		Main task cyclic time: 0.5ms, 1ms, 2ms, 4ms Periodic task cyclic time: Multiple setting of main task	
I/O Control method		Synchronized update with main task cycle (Refresh method)	
Program language		Ladder Diagram (Function block), Structured Text, G-Code	
Number of instruction	Operator	18	
	Basic function	202	
	Basic function block	174	
	Special function block	97	
Processing speed	Basic	6.25ns or more (General point/coil)	
	Move	5ns or more (Word type)	
	Arithmetic	30ns or more (Word type)	
Program	number	Max. 256	
	Capacity	10MB (Motion program), 10MB (NC program)	
Data area	Symbolic variable (A)	4.096KB (Retain setting available up to 2,048KB)	
	Input variable (I)	16KB	
	Output variable (Q)	16KB	
	Direct variable (M)	2,048KB (Retain setting available up to 1,024KB)	
	Flag variable	F	128KB
		K	18KB
		U	1KB
L		22KB ^{Note1)}	
N		49KB ^{Note1)}	
Timer		No limit in number of I/O points, Time range: 0.001-4,294,967,295sec (1,193hour)	
Counter		No limit in number of I/O points, Counter range: 64 bit range	
Program		Initial program, Main task program, Periodic task program, NC program	
Operation mode		RUN, STOP	
Restart mode		Cold, Warm	
Self-diagnosis function		Task cycle error, Task time occupancy rate exceed, memory abnormal, power abnormal, etc.	
Back-up method		Retain area setting in basic parameter or retain variable setting.	
Number of control axis ^{Note2)}	XMC-E32A, E32C	32 axes (Real/Virtual axis), 4axes (Virtual axis), 64 slaves (Max 32 slaves in case of 32 axes (Servo, INV) control)	
	XMC-E16A	16 axes (Real/Virtual axis), 2axes (Virtual axis), 32 slaves (Max 16 slaves in case of 16 axes (Servo, INV) control)	
	XMC-E08A	8 axes (Real/Virtual axis), 1axis (Virtual axis), 16 slaves (Max 8 slaves in case of 8 axes (Servo, INV) control)	
CAM operation	XMC-E32A, E32C	32 profiles/32,768 points	
	XMC-E16A	16 profiles/16,384 points	
	XMC-E08A	8 profiles/8,192 points	
Communication		EtherCAT (CoE: CANopen over EtherCAT, FoE: File Access over EtherCAT)	
Communication/Control period		0.5ms, 1ms, 2ms, 4ms (Same with main task period)	
Servo drive		EtherCAT servo drive which supports CoE	
Control unit		Pulse, mm, inch, degree	
Control method		Position, Velocity, Torque (Servo drive support), Synchronous, Interpolation	
Range of position / Velocity		±LREAL, 0	
Torque unit		Rated torque % designation	
Acc./Dec. profile		Trapezoidal, S-curve (Regarding Jerk value set by function block)	
Range of Acc/Dec		±LREAL, 0	
Manual operation		JOG operation	
Absolute system		Available (When using absolute encoder type servo drive)	
Encoder input	Channel	2 channels	
	Max.input	500kpps	
	Input method	Line drive input (RS-422A IEC specification), Available open collector output type encoder	
Input / Output	Input type	CW/CCW, Pulse/Dir, Phase A/B	
	Digital input / Output	8 point / 16 points (Tr. output)	
	Analog input / Output ^{Note1)}	Channels: 2ch In, 2ch Out, Input/Output voltage range: -10~10V / 0~10V / 1~5V / 0~5V Input current range: 4~20mA / 0~20mA, Max, resolution: 14bit (1/16000), Accuracy: 0.2% (25°C), 0.3% (0~55°C) Conversion speed: 0.5ms / channel, Absolute maximum input: Voltage 15 VDC, Current 30mA	
Coordinate systems	Applicable robot	Cartesian, Delta	
	Settings	XG5000	
	Control language	Function block	
SD Memory	Type	Micro SD/SDHC	
	File system	FAT32	
	Capacity	Max. 32GB installation (Memory over 8GB can use only 8GB of overall area)	
Embedded ethernet	Service	Program back-up/Restoration, Booting operation, Data log	
	Communication speed	Auto/10Mbps/100Mbps	
	Communication port	1 port	
	Communication distance	Max. distance between nodes: 100m	
Embedded cnet ^{Note2)}	Service	Loader service (XG5000), XGT Protocol (LS protocol), Modbus TCP FTP Server: Able to read/Write SD Memory files from other devices, SNTPT Client: Network time synchronization with server	
	Communication port	Ch 1: RS-232C, Ch 2: RS-485	
	Service	XGT Protocol, Modbus Protocol, User-defined Protocol, LS Bus (LS AC drive) Protocol	
USB	Performance	USB 2.0, 1 port	
	Service	Loader service (XG5000)	
Error indication		Indicated by LED	
Weight		790g	

Note1) Analog Input/Output are supported by XMC-E32A/E16A/E08A

Note2) Built-in Cnet communication is supported by XMC-E32C

HMI iXP3 Series



Features

- High-performance processor (Quad Core 1.6GHz)
- Provides camera (IP, USB) and multimedia (HDMI) functions
- Adjustable touch sensitivity: bare hands, gloves, etc.
- Multi-touch and gesture functions based on a capacitive touch screen
- Vector Image with No Distortion
- Providing network value-added services such as FTP, VPN, VNC, and DB
- Compliance with IACS UR E27 security standards

Specification

Item		iXP3-08□□A/D	iXP3-10□□A/D	iXP3-12□□A/D	iXP3-15□□A/D
Display type		TFT color LCD			
Screen size		8.4"	10.4"	12.1"	15"
Display resolution		800 x 600	1024 x 768		
Color indication		24-bit color (16.7M colors)			
Indication degree		Right and left: 80 deg. Top: 80 deg. Bottom: 60 deg.	Right: 75 deg. Top: 75 deg. Bottom: 75 deg.	Right and left: 80 deg. Top: 80 deg. Bottom: 80 deg.	
Backlight		LED method, automatic On / Off support			
Backlight lifetime		50,000 hours			
Touch panel		Capacitive Touch			
Audio output		Magnetic Buzzer (90dB)			
Processor		1.6GHz, Quad core			
Memory	Drawing Memory	128Mbyte			
	Backup RAM	1Mbyte			
Backup data		Date / Time data, Logging / Alarm / Recipe data, Non-volatile devices			
Battery		CR2032(3.0V/210mAh, approx. 3 years/25°C)			
Video Out		1 x HDMI			
Audio Out		3.5Φ x 1, 40mW			
Ethernet		2 x 10Base-T/100Base-TX/1000Base-T			
USB host	Standard	3 x USB 2.0 (Front x 1, Rear x 2)			
	Allowable current capacity	250mA(Front) 750 mA(Back; two Port combined)			
USB device		1 x USB 2.0 (Send / Receive front, PC and project data etc.)			
RS-232C		1 x RS-232C (DSUB 9 / Male type)			
RS-422/485		1 x RS-422/485 (Terminal Block)			
Multimedia	Animation	GIF format support			
	Video play	Support MP4, AVI, WMV formats			
	Camera	IP camera(Up to 8 channels), USB(Up to 2 channels)			
	HDMI	V2.0(Replication and expansion support)			
Multi-language		Can display 12 languages simultaneously			
Animation		GIF format support			
Recipe		Support			
Data logging		Support			
Script Launcher		Support			
Standard Certification		CE, KC, UL			
Protection standard		IP66(Front)			
Dimensions (mm)		240×180×60	271×212×60	313×239×60	395×294×66
Panel Cut (mm)		228.5×158.5	259.0×201.0	301.5×227.5	383.5×282.5
Power		A(AC100~220V), D(DC19.2~28.8V)			
Power consumption (W)	MAX	15	15.5	20.5	23
	When no external power is supplied	10	10.5	15	18
Weight (Kg)		1.87	2.35	3.0	4.6

LXP Series



Features

- Flexible installation options enabled by a separable display structure
- Supports display unit hot swap
- Improved visibility with large 19” and 24” displays
- Acquired T6-grade international explosion-proof certification
- Provides stability in N2 gas environment, which is required in semiconductor industry
- Multi-touch and gesture functions based on a capacitive touch screen
- Vector Image with No Distortion
- Providing network value-added services such as FTP, VPN, VNC, and DB

Specifications

Normal Type Display unit

Item		LXP-D1200	LXP-D1201	LXP-D1210	LXP-D1211	LXP-D1911	LXP-T1911	LXP-D2411	LXP-T2411	
Display	Display type	TFT color LCD								
	Color indication	24bit(16.7M)								
	Screen size	12.1"			19"			24"		
	Display resolution	1024×768			1280×1024			920X1080		
	Backlight	LED method, automatic On/Off support								
	Backlight lifetime	50,000 hour						100,000hour		
Touch	Touch panel	Capacitive touch								
	Operation mode	Bare hands, Glove, Waterproof								
	Sensitivityadjustment	10 steps adjustable for each mode								
	Function	Multi-touch, Zoom in/out, change screen								
Built-in camera	Resolution	720p, 30fps								
	Support	○	○	○	-	-	-	-	-	
XP-VLink		○	-	-	-	-	-	-	-	
Buzzer		90dB, 9 steps adjustable				Unsupported				
USB	Device	USB 2.0, 1 channel				USB Type-B, 1 channel (Touch I/F)				
	Host	USB 2.0, 1channel, 500mA/channel				Unsupported				
Certification	Standard	CE, KC, UL, IP66				CE, KC, UL, IP54		CE, KC, IP54		
	Dimensions (mm)	320×261×44				431.5 x 364.5 x 48		579.4 x 347 x 46.5		579.4 x 347 x 48.0
Construction	Panel Cut (mm)	306×247				383.5×282.5		552 x 319		550 x 317
	Weight (Kg)	3.0kg				4.5kg				5kg
	Power (V)	15.5Vdc				12V ^{Note1)}				12Vdc
Power	Power (V)	9W		8W		20W		28W		
	Display Installation	Panel Installation/VESA Mount ^{Note2)}				Panel Installation	VESA Mount	Panel Installation	VESA Mount	
Main Unit	LXP-M00D	○	-	○	-	○	○	○	○	
Combination	LXP-M01D	-	○	-	○	-	-	-	-	

Note1) LXP-D1911 is powered form LXP Main Unit

Note2) The panel installation is installed according to the panel cut size for each display, and the VESA mount is installed on a monitor arm that meets the VESA hole standard.

Normal Type Main Unit

Item		LXP-M00D	LXP-M01D
Processor		1.6GHz, Quad core	
Memory	Drawing memory	128Mbyte	
	Operation RAM	4GByte	
	Backup RAM	1Mbyte	
XP-VLink		○	-
RTC		Support, Battery CR2032(about 3years/25°C)	
Interface	HDMI	V2.0, 1 channel	
	Audio out	3.5Φ, 40mW, 1 channel	
	Extended Interface	Support, 64GB extended memory	
Storage	SD	Max. 256GB(SDXC, SDHC)	
	USB host	USB 3.0, 2 channel	
	LAN0	10Base-T/100Base-TX/1000Base-T	
Communication	LAN1	Auto MDIX / RJ-45	
	COM1	RS-232C, RS-422/485, Isolated Baud rate: 9,600~115,200(Max. 5kbps) / 9pin D-sub(Female)	
	COM2	RS-232C, RS-422/485, 5Vdc/250mA Power out Baud rate: 9,600~115,200(Max. 5kbps) / 9pin D-sub(Female)	
	COM3	RS-485 / Baud rate: 9,600~115,200(Max. 5kbps) / 3pin Open connector	
	Certification	Standard certification CE, KC, UL, IP20	
Structure	Dimension (mm)	220 x 147 x 51.3	
	Weight (Kg)	1.4kg	
Power	Power (V)	24Vdc	
	Power consumption (W)	7W	

HMI iXP2 Series



Features

- 1 GHz dual core CPU
- 1 GB display data and 1 MB back-up memory
- Aluminum frame & Reinforced glass
- Ethernet 2 ch, RS-232C 1ch, RS422/485 1ch.
- HDMI/audio output/USB host/device
- Multi touch & screen gesture (Swipe, Flick)
- Dual monitor clone / Extended mode
- IP66 (NEMA 4X) rating

Specification

Item	iXP2-0800A/D	iXP2-1000A/D	iXP2-1200A/D	iXP2-1500A/D
Display Type	TFT color LCD			
Screen Size	8.4"	10.4"	12.1"	15"
Display Resolution	800×600	1024×768		
Color Indication	24-bit color (16.7M colors)			
Backlight	LED method, Automatic On / Off support			
Backlight Lifetime	40,000 hour			
Touch Panel	Capacitive touch			
Audio Output	Magnetic buzzer (85dB)			
Processor	1GHz, Dual core			
Memory	Flash	1GB		
	Operating RAM	1GB		
	Backup RAM	1 Mbyte		
Backup Data	Date / Time data, Logging / Alarm / Recipe data, Non-volatile devices			
Battery	CR2032 (3.0V/210mAh, About 3years/25°C)			
Video Output	1 × HDMI			
Ethernet	1 × 10Base-T / 100Base-TX, 1 × 10Base-T / 100Base-TX / 1000Base-T			
USB Host	3×USB2.0 (Front×1, Rear×2)			
USB Device	1 × USB 2.0 (Send / Receive front, PC and project Data Etc.)			
RS-232C	1 × RS-232C (DSUB9 / Male type)			
RS-422/485	1 × RS-422/485 (Terminal block)			
Multi-Language	Can display 12 languages simultaneously			
Animation	GIF format support			
Recipe	Support			
Data Logging	Support			
Script Launcher	Support			
Standard Certification	CE, KC, UL, IECEx, KCs, ATEX (Separate product explosion proof: iXP2-xxxxA/D-EX)			
Protection Standard	IP66, Conform to the UL type 4x, NEMA 4x standard			
Explosion Proof	Ex nA IIC T5 Gc, Ext c: IIC T100°C Dc IP64			
Dimensions (mm)	240×180×60	271×212×60	313×239×60	395×294×66
Panel Cut (mm)	228.5×158.5	259.0×201.0	301.5×227.5	383.5×282.5
Power	iXP2-xxxxA: AC100/240V, iXP2-xxxxD: DC24V			
Power Consumption (W)	25	25	30	30
Weight (Kg)	1.87	2.35	3.0	4.6

eXP2 Series



Features

Fully compatible with eXP

- Panel cut, interface, design, and drawing file are 100% compatible.

Superior Performance

- ARM Cortex A8 800MHz, eMMC 4G, DDR3

Enhanced product reliability

- LCD Backlight lifespan extended
- Non Battery Type NVRAM

Variety of interfaces and functions

- Various communication drivers and Micro SD I/F available

Specifications

Item	eXP2-04□*0D	eXP2-05□*0D	eXP2-05□*2D	eXP2-07□*0D	eXP2-07□*1D	eXP2-07□*2D	eXP2-10□*0D	eXP2-10□*1D	
Display Type	TFT Color LCD								
Screen Size	10.9cm (4.3")	14.2cm (5.6")		17.8cm (7")			25.9cm (10.1")		
Display Resolution	480 x 272	640 x 480		800 x 480			1024 x 600		
Color Indication	24Bit Color (16.7M)	18Bit Color (262,144)		24Bit Color (16.7M)			24Bit Color (16.7M)		
Indication Degree	Left/Right: 60 deg. Upper: 40 deg. Lower: 50 deg	Left/Right: 60 deg. Upper: 40 deg. Lower: 60 deg.		Left/Right: 70 deg. Upper: 50 deg. Lower: 70 deg.			Left/Right: 70 deg. Upper: 50 deg. Lower: 70 deg.		
Backlight	LED Type (Supports Backlight Auto-off Function)								
Backlight Duration	50,000 Hours	20,000 Hours		50,000 Hours			30,000 Hours		
Touch Panel	4-Wire Resistive, Analog								
Audio Output	Magnetic Buzzer (85dB)								
Process	800MHz	800MHz		800MHz			800MHz		
Memory	Drawing Memory	64MB	64MB		64MB			64MB	
	Operating RAM	512MB	512MB		512MB			512MB	
	Operating RAM	128KB	128KB		128KB			128KB	
Backup Data	Date/Hour Data, Logging/Alarm/Recipe Data and Nonvolatile Device								
Battery Life	Approx. 3 years (Operating Ambient Temperature of 50°C)								
Ethernet	1 Channel, IEEE802.1a, 10Base-T/100Base-TX		-	1 Channel, IEEE802.1a, 10Base-T/100Base-TX		-	1 Channel, IEEE802.1a, 10Base-T/100Base-TX		
USB Host	1 Channel, USB 2.0 Host (Mouse, keyboard, printer, USB flash drive, etc.)								
USB Device	-	1 Channel, USB 2.0 Device (for Download and Upload Project)					1 Channel, USB 2.0 Device (for Download and Upload Project File)		
Micro SD Card	-	-	-	1 Channel SDHC Class10	-	-	1 Channel SDHC Class10		
RS-485, RS-232C	1 Channel, RS-232C (DSUB 9/Male Type)			2 Channels, RS-485, RS-232C (DSUB 9/Male Type)					
RS-422/485	1 Channel, RS-422/485 (DSUB 9/Male Type)			1 Channel, RS-422/485 Mode (Terminal Type)					
Multi-language	Up to 12 Language Simultaneously								
Animation	GIF Format is Available								
Recipe	Available								
Data Logging	Available								
Script Executor	Available								
Certifications	CE, UL(cUL), UL Type 4X, KC		CE, UL(cUL), KC	CE, UL(cUL), UL Type 4X, KC		CE, UL(cUL), KC	CE, UL(cUL), UL Type 4X, KC		
Protection Standard	IP65 ^{Note 1)}		IP65 ^{Note 1)}		IP65 ^{Note 1)}			IP65 ^{Note 1)}	
Dimension (mm)	128 x 102 x 32.5		165 x 132.5 x 36.1		208 x 154 x 44.4			276 x 218 x 35.1	
Panel Cut (mm)	119 x 93		156 x 123.5		192 x 138			260 x 202	
Rated Voltage	DC24V		DC24V		DC24V			DC24V	
Power Consumption (W)	4		5.5		6			6	
Weight (kg)	0.27		0.43		0.59			1.0	

□*0 (WinCE 7.0 Core), 1 (WinCE 7.0 Pro)

Note 1): IP66 for UL Type 4X models.

New Handheld HMI

iXP2H Series



3 - Position Enable Switch

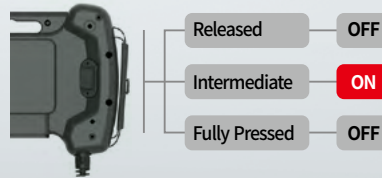

Clear Visibility

- Excellent visibility with high definition and wide screen view
- 1024 X 600 resolution
- 16M color

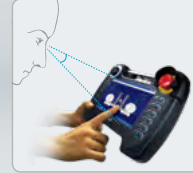

Project Transfer

- Easy project creation by XP-builder
- Convenient downloading/Uploading of project files via USB port and ethernet (Multi-language supported)

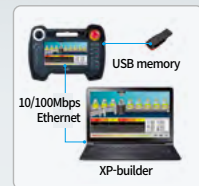

Specification

Model	iXP2H-0702D Series	iXP2H-0704D Series
Display Type	TFT color LCD	
Screen Size	7"	
Resolution	1024 x 600 pixels	
Color Indication	24-bit color (16.7M colors)	
Backlight	LED method, Automatic On/Off support	
Backlight Lifetime	50,000 hours	
Touch Panel	Resistive overlay (Pressure type)	
Audio	Magnetic buzzer (12Ø 85 dB)	
Processor	ARM cortex-A9 800 MHz, Single core	
Memory	Flash	8 GB (Small memory : 128 MB)
	Operating RAM	1 GB
	Backup RAM	1 MB
Backup Type	Date/Time data, Logging, Alarm, Recipe data, Non-volatile device	
Battery	CR1220 (3.0V/210 mAh, Around 3 years/25°C)	
Ethernet	1 x 10Base-T/100Base-TX	
USB Host	1 x USB 2.0 (Below x 1)	
RS-232C	1 x RS-232C (Terminal block)	-
RS-485	-	1 x RS-485 (Terminal block)
Multiple Languages	Simultaneous display of 12 languages	
Animation	GIF format support	
Recipe	Supported	
Data Logging	Supported	
Script Launcher	Supported	
Standard Certification	CE, KC	
Protection Standard	IP42 (Front)	
Dimensions (mm)	195×270×72 (Excluding cables)	
Power	DC 24 V ±5%	
Power Consumption (W)	12	
Weight (Kg)	1.0 (Excluding cables)	

Product list

Model	Features
iXP2H-0702D05	RS-232C, Ethernet, 5m cable
iXP2H-0702D10	RS-232C, Ethernet, 10m cable
iXP2H-0704D05	RS-485, Ethernet, 5m cable
Model	Features
iXP2H-0704D10	RS-485, Ethernet, 10m cable
iXP20-JB0D	Handy junction box (Conversion adapter)

System configuration and features



- 1 TFT-LCD**
1024 x 600 TFT LCD, 16.7M color display resistive overlay
- 2 Emergency stop switch**
Immediately stops the control device or turns off the power as a safety feature
- 3 Left keypad**
Direction key F1, F2, F3: User defined RGB LED: User defined
- 4 Right keypad**
User defined
* Generally used as shortcut key of each axis of robot.
- 5 Extension device**
Slot of the USB extension device
 - When shipped, it is fastened with a separate cover.
 - When used, the cover can be removed with a phillips head (+) screwdriver for use.
- 6 Reset switch**
Switch for resetting the system
- 7 Debug port**
A debugging port for developers
- 8 USB host**
Connect to USB memory : Backup and send logging, Recipe, Alarm, and project data.
Connect to user interface : Use the mouse and keyboard.
- 9 USB device(Option)**
USB device port (Unsupported)
- 10 SD - Card**
Software update SD memory (Store data)
- 11 Enable Switch**
Released : Disable
Intermediate : Enable
Fully Pressed : Disable

Junction Box

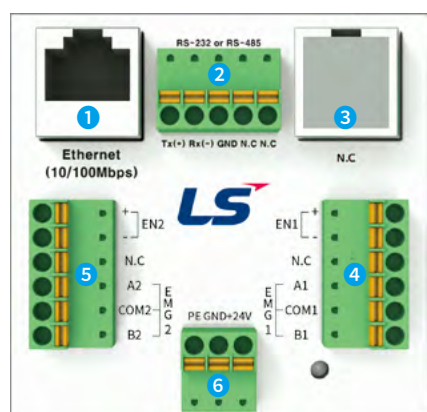

- 1 Ethernet Port**
Ethernet : 10Base-T/100Base-TX/1000Base-T
• Connector for Ethernet connection
- 2 Serial terminal block**
RS-485/232C communication connector
• 0702D(for RS-232 model): Tx, Rx, GND
• 0704D(for RS-485 model): TRx+, TRx-
- 3 N.C** Not used
- 4 Switch 1 terminal block**
Signal that is controlled from the front side switch of the product.
• Enable, Emergency (A contact, B contact) switch
- 5 Switch 2 terminal block**
Signal that is controlled from the front side switch of the product.
• Enable, Emergency (A contact, B contact) switch
- 6 Power terminal block**
DC 24 V input terminal block

HMI

PC-based S/W HMI

wLXP

- Full compatibility with XGT Panel features and drawing files (LXP, iXP3, mPC)
- PC-based XGT Panel solution
- High Quality Vector Image Library
- Animation editor
- Supports up to 2 USB cameras
- Supports data backup via FTP server

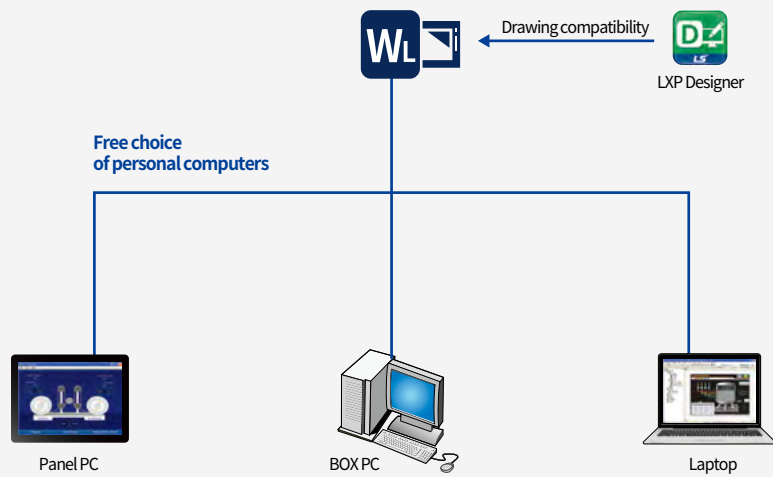

Purchase method

Case 1) Installation type for customer's PC

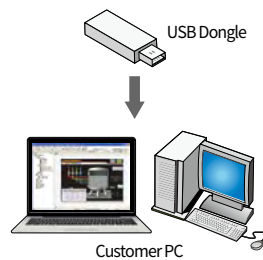

Case 2) XGT PC integrated type

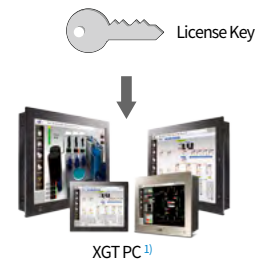

¹⁾ When purchased with LS Electric XGT PC, SW installation and license key authentication are included in the delivery.

wXP

- PC solution for XGT Panel, an HMI device
- Function to remotely monitor and control the operation status of field PLC through the screen on the PC
- Monitor and control equipment of global local factories through Ethernet from the headquarters PC
- Compatibility with XGT Panel functions and all drawing files (Monitoring and control on existing XGT Panel operate the same way on the PC without changing the drawing)
- Simultaneous support for multiple languages (12 languages)
- Users can arbitrarily specify the screen resolution

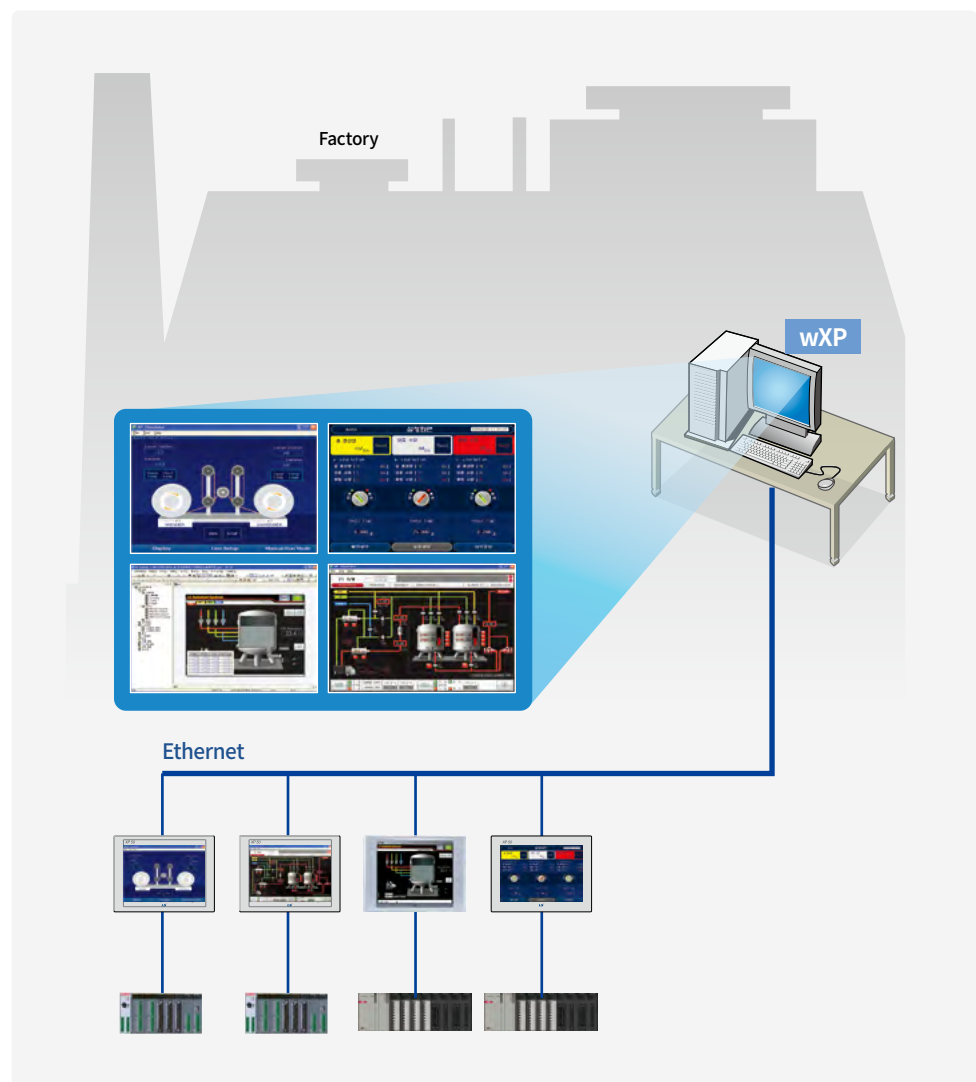

HMI

SCADA Software XGT InfoU

The new web plant feature is available in XGT infoU. Mobile with web-based surveillance software, It's easy to use with a tablet.



Special Features

- Open architecture with high scalability and compatibility HMI/SCADA operating system
- Simple user interface and application of advanced graphics technology
- Redundant servers, Multi-client support
- Web client, Android app support
- Support for various DBs and various industrial protocols
- User-centric, Convenient report creation
- XGT infoU web plant
 - HTML5 based monitoring software features
 - Graphic surveillance control, Alarm, Trend
 - Supports a variety of graphics formats, Including BMP, JPG, GIF, SVG, PNG, etc.
 - Support for dynamic characteristics, Event scripts, and smart symbols

Web Plant Use Cases

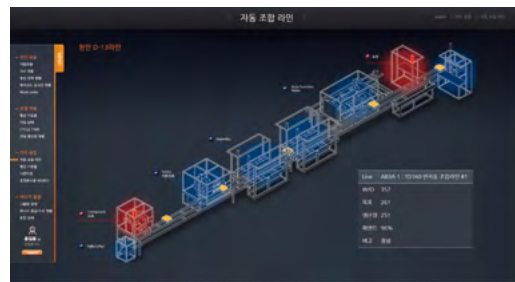

Monitoring and control of the automatic assembly line of LS cheonan plant

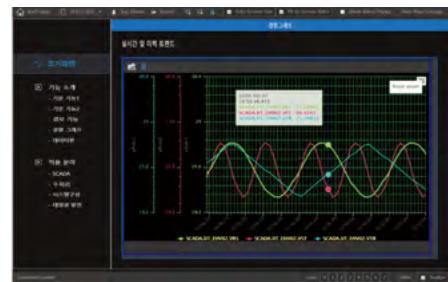

Real-time history and trend alarm functions

System Configuration

Surveillance System

Monitor Field Data Collected by Server

Server

Control Processes and Monitor Field Data Collection

Field Control Panel

Monitor and Control On-Site Devices

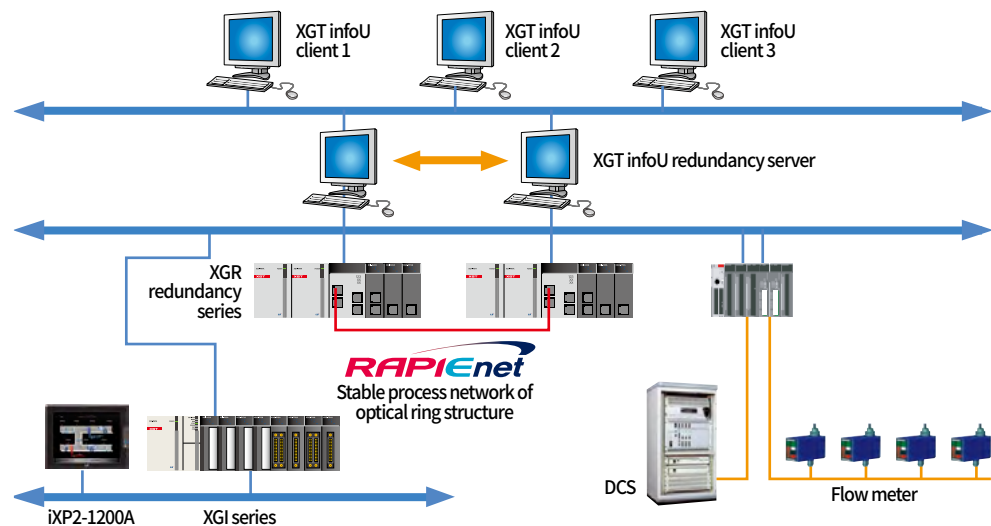

- On-site devices scattered in remote areas can be collected through efficient communication and various alarm information can be managed.
- On-site trip data can be synchronized using SOE module and the exact cause of accident can be analyzed.
- DataBase connectivity and task capabilities allow tagging and output to general-purpose DataBase such as MS SQL and oracle. Efficient data sharing with MES or ERP systems

XGT InfoU Model List

Model	Version	Description
InfoU-RC-75/150/500/1K/2K/MAX	Developer & Runtime version	InfoU Development version, 75/150/500/1000/2000/MAX TAG
InfoU-RT-75/150/500/1K/2K/MAX	Runtime version	InfoU Running version, 75/150/500/1000/2000/MAX TAG
InfoU-OP-WEBMAX/150/500/1K/2K	Web browser version	WEB version, MAX USER, MAX TAG/150/500/1000/2000

XPC

Panel PC, XPC Series with latest specs quad core CPU

NTP-KF Series

Panel PC with latest intel core CPU

- Intel 6th generation core i3/i5/i7 CPU
- Built-in SSD 128GB, 4GB RAM For maximum performance
- Low-power, Eco-friendly products by minimizing energy consumption
- Fanless structural design enables low heat/noise
- Easy wiring via the wireless connection (Optional)
- A broad lineup of 12" to 19"

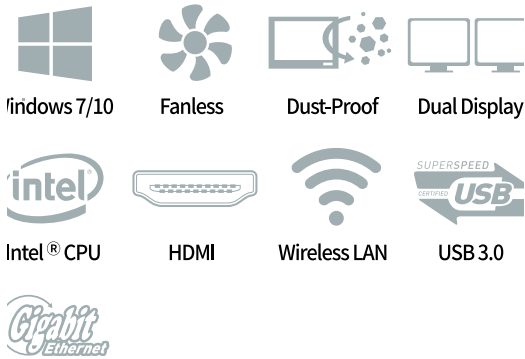

XPC-KF Model List

Model	Description
XPC-NTP12KF	12", Intel 6th core i3/i5/i7 CPU, 4G RAM, SSD 128G
XPC-NTP15KF	15", Intel 6th core i3/i5/i7 CPU, 4G RAM, SSD 128G
XPC-NTP17KF	17", Intel 6th core i3/i5/i7 CPU, 4G RAM, SSD 128G
XPC-NTP19KF	19", Intel 6th core i3/i5/i7 CPU, 4G RAM, SSD 128G

NTP-BF Series

Panel PC with latest intel core CPU

- Latest intel 2.0GHz quad core CPU
- Built-in SSD 128GB, 4GB RAM for maximum performance
- Low-power, Eco-friendly products by minimizing energy consumption
- Fanless structural design enables low heat/noise
- Easy wiring via the wireless connection (Optional)
- 6 broad lineups from 7" to 19"

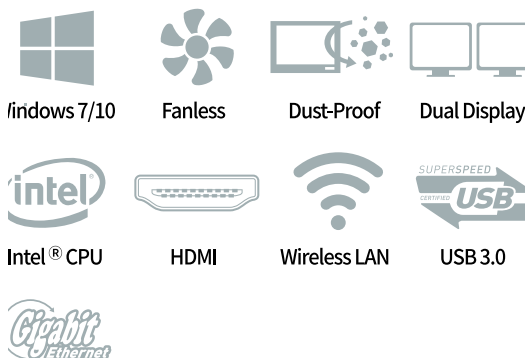

XPC-BF Model List

Model	Description
XPC-NTP07BF	7", Intel baytrail-D quad core, 4G RAM, SSD 128G
XPC-NTP10BF	10", Intel baytrail-D quad core, 4G RAM, SSD 128G
XPC-NTP12BF	10", Intel baytrail-D quad core, 4G RAM, SSD 128G
XPC-NTP15BF	15", Intel baytrail-D quad core, 4G RAM, SSD 128G
XPC-NTP17BF	17", Intel baytrail-D quad core, 4G RAM, SSD 128G
XPC-NTP19BF	19", Intel baytrail-D quad core, 4G RAM, SSD 128G

User-oriented Xmotion servo system completes your optimal solution. its high-performance vector, precision and speed control are user-friendly and cost effective.



Servo Drive

iX7M Series



One Servo Drive Controls Up To Four Axes

- High space efficiency and low price
- Three platforms (2-, 3- and 4-axis) provided
- Applicable to various areas, such as robot, CNC machining, 3D printing and automotive manufacturing

Minimized Installation Space, Maximized User Convenience

- Up to 40% reduced space compared to single-axis configuration
- Minimized cable wiring reduces installation space

Precision, High Response Control Solution

- EtherCAT-based communication supports up to 125µs communication cycle

iX7NH Series



Compact & Convenience

- Optimized installation space by highly efficient heat dissipation - 100W ~ 1kW Drive
- Minimized drive depth for 100W and 200W drive by development and application of mini heatsink - 172.5mm → 145.2mm ; volume reduced by 16%

More Variety of Supported Encoders & Functionalities

- BiSS, Quadrature, Tamagawa, Panasonic, EnDat 2.2, SSI, Nikon and Sinusoidal (Optional)
- Temperature monitoring by encoders supported
- Capable of saving up to 4 maximum channels such as alarm code & alarm occurrence time/date
- Enhanced USB OTG(On-The-Go) function: Parameter, alarm history back-up, firmware update

Faster Communication Provided in More Diverse Methods

- Fieldbus: EtherCAT & Modbus TCP
- Min. Communication cycle time : 0.125ms
- Built-in web server function

L7NH Series



Real-time control through EtherCAT

- High speed, Real-time capability and synchronization mechanism
- Supporting CoE, EoE and FoE
- Improved EtherCAT communication speed (Min. 250µs, DC support)
- Improved speed response(1kHz) frequency

Support various motor and encoder drive

- Supporting rotary, DD and motor drive (Supporting 3rd party motor)
- Quadrature, BiSS-C, Tamagawa serial abs, EnDat 2.2, Resolver

Improved control performance

- Improved control bandwidth
- Vibration control by real-time FET
- Providing 4-step notch-filter
- Real-time gain tuning function

L7P Series



Providing program function built-in single axis position determination module

- Supporting position control mode by pulse input
- Possible to use without upper controller
- Position control mode
- Modbus RTU protocol (RS-422)

Support various motor and encoder drive

- Supporting rotary, DD and motor drive (Supporting 3rd party motor)
- Quadrature, BiSS-C, Tamagawa serial abs, EnDat 2.2, resolver

Improved control performance

- Improved control bandwidth
- Vibration control by real-time FET
- Providing 4-step notch-filter
- Real-time gain tuning function

L7NHF Series



Real-time control through EtherCAT

- High speed, Real-time capability and synchronization mechanism
- Supporting CoE, EoE and FoE
- Improved speed response (1kHz) frequency
- Improved communication speed by applying 16bit-bus
 - Improved chip communication speed
 - Improved EtherCAT communication speed

Fully-closed loop control

- Switch among semi-closed loop control, Fully-closed loop control and dual feedback control
- Fully-closed loop control provides quick response with internal and external encoder position values
- Fully-closed loop control ensures high-precision control during machine operation

L7C Series



Control power/main power unification

- Unification of power for integrated control board and power board
- 0.1~1kW drive line-up for single phase AC220V support

Optimal system implementation with competitive cost ratio

- Unification of power for integrated control board and power board

Maintain and improve L7S specification

- Compatibility with existing L7S I/O pin map
- Maintain current control cycle (10kHz), Speed/position control cycle (5kHz)
- Added operation mode (Indexing mode) and improved memory (1MB)

PEGA Series



Enhanced efficiency integrated servo system

- Cost effective from installation by integrated system of motor, encoder cable and drive
- Maximization for useful space when installed at limited and small space
- High effectiveness for application of multi axis because there is no limitation for space of installation

Real-time control through EtherCAT

- High speed, Real-time capability and synchronization mechanism
- Improved EtherCAT communication speed
- Supporting CoE, EoE and FoE

Servo Drive

PHOX Series



Real-time control through EtherCAT

- High speed, Real-time capability and synchronization mechanism
- Improved communication speed by applying 16Bit-bus
 - Improved chip communication speed
 - Improved EtherCAT communication speed
- Supports CoE, EoE and FoE
- Improved speed response (1kHz) frequency

Variable switching frequency

- 16 / 32 / 48kHz

Progammig function including single axis position module

- Positioning control mode with pulse inputs
- Supports the indexing mode
- Provides position control through I/O or HMI without the position control module

Servo Motor

F Series

Flat type rotating servo motor

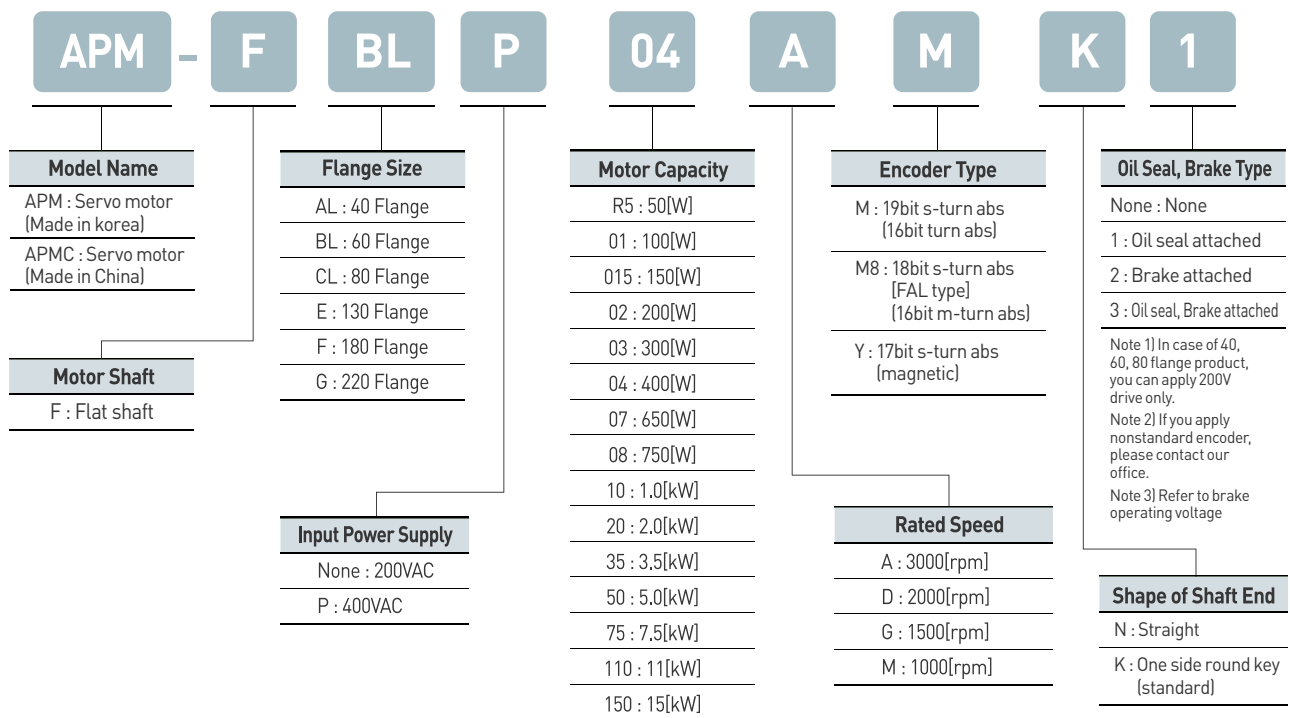

MDM Series

Direct-drive motor

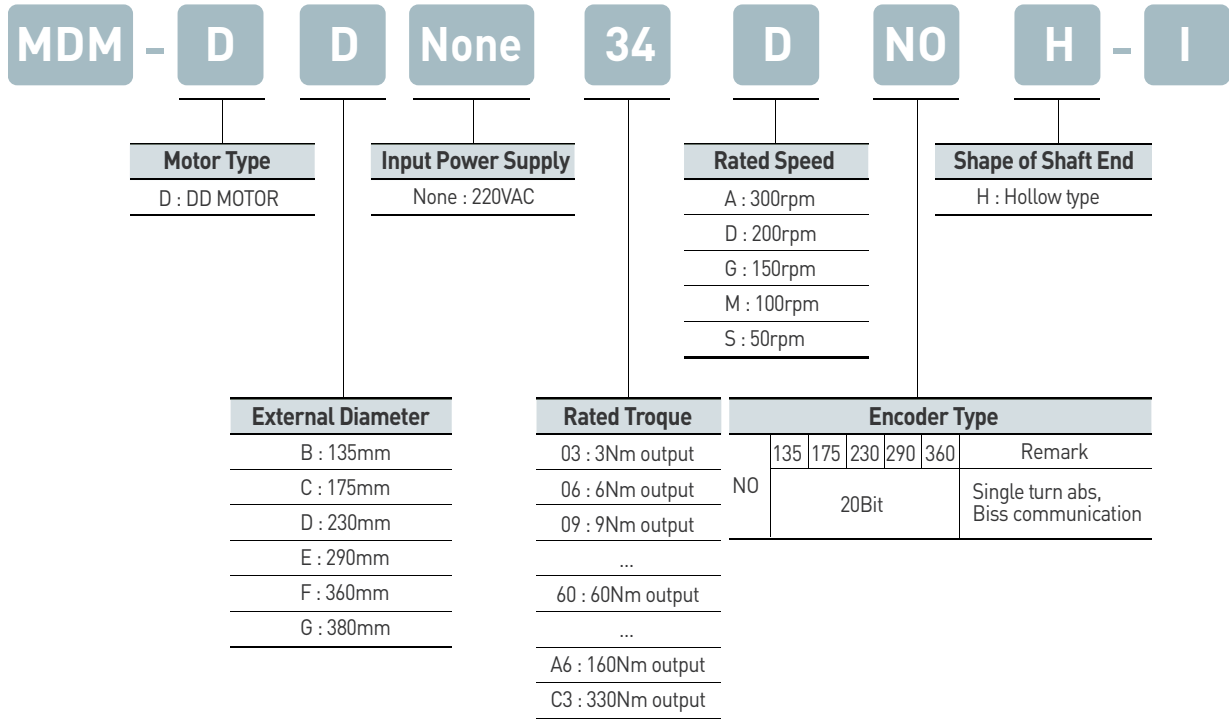

MDM Flange type Series

Direct-drive motor flange type

Resolution 16,777,216 [Pulse/rev] (24Bit, single turn)

※ Standard product: Resolution 1,048,576 [Pulse/rev] (20Bit, single turn)

Compact size DD Motor

• 30% smaller size than standard product

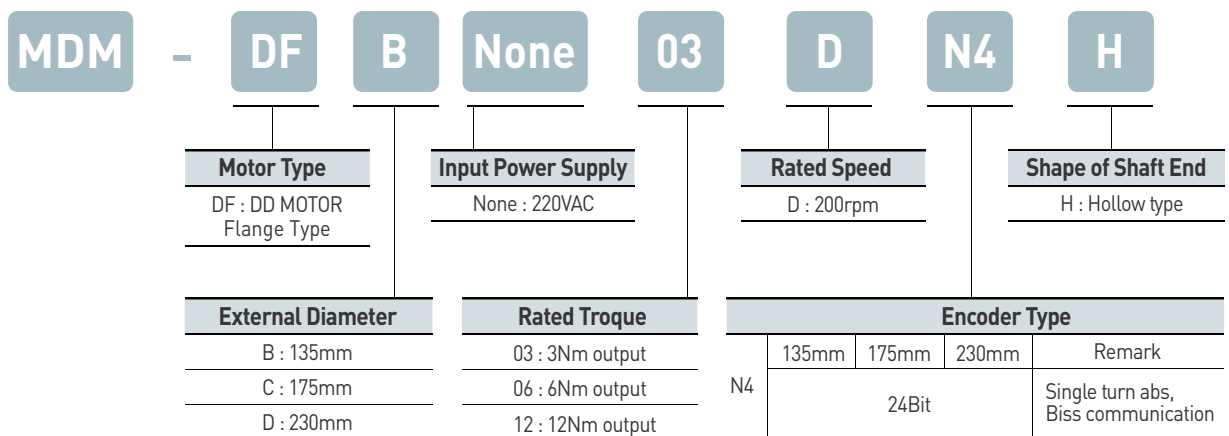

iX7NHA Drive

Item		Part Number	iX7NHA001U	iX7NHA002U	iX7NHA004U	iX7NHA008U	iX7NHA010U	iX7NHA020U	iX7NHA035U	
Input Power	Main Power		1-Phase AC100 ~ 120[V], 1-Phase AC200 ~ 240[V], 3-Phase AC200 ~ 240[V], (-15 ~ +10[%]), 50 ~ 60[Hz]			1-Phase AC200 ~ 240[V], 3-Phase AC200 ~ 240[V], (-15 ~ +10[%]), 50 ~ 60[Hz]		3-Phase AC200 ~ 240[V], (-15 ~ +10[%]), 50 ~ 60[Hz]		
	Control Power		1-Phase AC100 ~ 120[V] 1-Phase AC200 ~ 240[V] (-15 ~ +10[10%]), 50 ~ 60[Hz]			1-Phase AC200 ~ 240[V] (-15 ~ +10[10%]), 50 ~ 60[Hz]				
Rated Current [A]			1.4	1.7	3.0	5.2	6.75	13.5	16.0	
Peak Current [A]			4.9	5.95	10.5	18.2	20.25	40.5	48.0	
Encoder Type			Quadrature (Incremental) , BiSS-B, BiSS-C(Absolute, Incremental) Tamagawa Serial(Absolute, Incremental), EnDat 2.2, Sinusoidal, Analog Hall, SSI, Nikon, Panasonic							
Control Performance	Speed Control Range		Max. 1 : 5000							
	Speed Variation Ratio		±0.01[%] or less (Load variation 0~100[%]), ±0.1[%] or less (temperature: 25±10[°C])							
	Torque Control Repetition Accuracy		±1[%] or less							
EtherCAT Specification	Communication Standard		FoE (Firmware download) EoE (Parameter setting by UDP, Tuning, Secondary function, Parameter copy) CoE (IEC 61158 Type12, IEC 61800-7 CiA 402 Drive profile)							
	Physical Layer		100BASE-TX(IEEE802.3)							
	Connector		RJ45 x 2							
	Communication Distance		Distance between nodes 100[m] or less							
	DC (Distributed Clock)		Synchronization by DC(Distributed Clock) mode. Minimum DC cycle: 125[us]							
	LED Display		Link Act IN, Link Act OUT, RUN, ERR							
	CiA 402 Drive Profile		Profile Position Mode, Profile Velocity Mode, Profile Torque Mode, Cyclic Synchronous Position Mode Cyclic Synchronous Velocity Mode, Cyclic Synchronous Torque Mode, Homing Mode							
Digital Input, Digital Output	Digital Input		Input Voltage range: DC 12[V] ~ DC 24[V] / Total 6 input channels (allocable) Inputs of total 15 functions are selectively allocable (*POT, *NOT, *HOME, *STOP, *PCON, *GAIN2, P_CL, N_CL, PROBE1, PROBE2, EMG, A_RST, SV_ON, LVSF1, LVSF2) Note) *: Fundamentally allocated signals							
	Digital Output		Service rating: DC 24[V] ±10%, 120[mA] total 3 channels (allocable) Total 11 outputs are selectively allocable (*BRAKE, *ALARM, *READY, ZSPD, INPOS, TLMT, VLMT, INPOS2, INSPD, WARN, TGON) Note)* Automatically allocated signals							
Encoder Decimation Output			Differential Line Driver 3 channels AO, /AO, BO, /BO, ZO, /ZO up to 6.5 [Mpps] on 4x interpolation							
Analog Input & Output	Analog Input		Input voltage range: -10 ~ +10[V], Function: analog torque limit (1 channel, unallocable)							
	Analog Output		Total 2 channels (Allocable): able to selectively allocate total 25 types of output							
Safety Function			2 Input Channels(STO1 and STO2), 1 Output Channel(EDM)							
USB Communication	Function		Firmware download, tuning, test drive, monitoring, parameter duplication							
	Communication Standard		Complies with USB 2.0 Full Speed and OTG 2.0 standards							
	Accessible Device		PC or USB Storage device							
Embedded Function	Dynamic Braking		Standard built-in brake (Activated when the servo alarm goes off or when the servo is off).							
	Regenerative Braking		Built-in by default (100W & 200W excluded)							
	Display Function		7-segment display (5 digits)							
	Self-setting Function		Drive node address setting is possible using rotary switch							
	Additional Function		Gain tuning, alarm history, jog operation, home searching							
Operation Environment	Protection Function		Overcurrent, overload, overheat, overvoltage, insufficient voltage, overspeed, abnormal state of encoder, position following error, current detecting error							
	Operating Temperature / Storage Temperature		0 ~ +50[°C] / -20 ~ +65[°C]							
	Operating Humidity / Storage Humidity Environment		Under 80[%]RH / Under 90[%]RH (noncondensing) Keep indoors. Avoid corrosive / flammable gas or liquid.							

L7NHA Drive

Type Name		L7NHA001U	L7NHA002U	L7NHA004U	L7NHA008U	L7NHA010U	L7NHA020U	L7NHA035U	L7NHA050U	L7NHA075U	L7NHA150U
Input Power	Main Power Supply	3 phase AC200 ~ 230[V](-15 ~ +10[%]), 50 ~ 60[Hz]									
	Control Power Supply	Single phase AC200 ~ 230[V](-15 ~ +10[%]), 50 ~ 60[Hz]									
Rated Current[A]		1.4	1.7	3.0	5.2	6.75	13.5	16.7	32	39.4	76
Peak Current[A]		4.2	5.1	9.0	15.6	20.25	40.5	50.1	90.88	98.5	190
Encoder Type		Quadrature (Incremental) BiSS-B, BiSS-C (Absolute, Incremental) Tamagawa serial (Absolute, Incremental) EnDat 2.2 Sinusoidal Analog hall									
Control Performance	Speed Control Range	Maximum 1: 5000									
	Frequency Response	Maximum 1[kHz] or above (When the 19-bit serial encoder is applied)									
	Speed Variation Ratio	±0.01[%] or lower (When the load changes between 0 and 100%) ±0.1[%] or less (Temperature of 25°C[±10])									
	Torque Control Repetition Accuracy	Within ±1%									
EtherCAT Communication Specifications	Communication Standard	FoE (Firmware download) EoE (Parameter setting by UDP, Tuning, Secondary function, Parameter copy) CoE (IEC 61158 type12, IEC 61800-7 CIA 402 drive profile)									
	Physical Layer	100BASE-TX (IEEE802.3)									
	Connector	RJ45x2									
	Communication Distance	Within connection between nodes 100[m]									
	DC(Distributed Clock)	By DC mode synchronism. Minimum DC cycle: 250[us]									
	LED Display	LinkAct IN, LinkAct OUT, RUN, ERR									
	Cia402 Drive Profile	Profile position mode Profile velocity mode Profile torque mode Cyclic synchronous position mode Cyclic synchronous velocity mode Cyclic synchronous torque mode Homing mode									
Digital Input / Output	Digital Input	Input voltage range : DC 12[V] ~ DC 24[V] Total 8 input channels (Allocable) Above 12 functions can be used selectively for assignment. (*POT, *NOT, *HOME, *STOP, *PCON, *GAIN2, *P_CL, *N_CL, PROBE1, PROBE2, EMG, A_RST)									
	Digital Output	Service rating : DC 24[V] ±10%, 120[] Total 4 input channels (Allocable) Above 11 functions can be used selectively for assignment. (*BRAKE±, *ALARM±, *READY±, *ZSPD±, INPOS±, TLMT±, VLMT±, INSPD±, WARN±, TGO±, INPOS±)									
Safety Function		2 input channels (STO1, STO2), 1 output channels (EDM±)									
USB Communication	Function	Firmware download, Parameter setting, Tuning, Secondary function, Parameter copy									
	Communication Standard	USB 2.0 Full speed (Applies standard)									
	Connect	PC or USB storing medium									
Internal Function	Dynamic Braking	Standard built-in brake (Activated when the servo alarm goes off or when the servo is off)									
	Regenerative Braking	Default mult-in(Excluding 15kW), External installation possible									
	Display Function	7 segments (5DIGIT)									
	Self-setting Function	The [MODE] key changes the content displayed in 7 segments									
	Additional Function	Auto gain tuning function									
Protection Function		Overcurrent, Overload, Overvoltage, Insufficient voltage, Main power input problem, Control power input problem, Overspeed, Motor cable, Overheat(Power module overheat, Abnormal drive operation's temp), Encoder problem, Over-regenerative, Sensor problem, Communication problem									
Operation Environment	Operating Temperature / Storage Temperature	0 ~ 50[°C] / -20 ~ 70[°C]									
	Operating Humidity / Storage Humidity	Below 80[%]RH / Below 90[%]RH (Avoid dew-condensation)									
	Environment	Indoor, Avoid corrosive, Inflammable gas or liquid, and electrically conductive dust.									

Servo Drive

L7NHB Drive

Type Name		L7NHB010U	L7NHB020U	L7NHB035U	L7NHB050U	L7NHB075U	L7NHB150U
Input Power	Main Power Supply	3 phase AC380 ~480[V](-15 ~ +10[%]), 50 ~ 60[Hz]					
	Control Power Supply	Single phase AC380 ~ 480[V](-15 ~ +10[%]), 50 ~ 60[Hz]					
Rated Current[A]		3.7	8	10.1	17.5	22.8	39
Peak Current[A]		11.1	24	30.3	47.25	57	97.5
Encoder Type		Quadrature (Incremental) BiSS-B, BiSS-C (Absolute, Incremental) Tamagawa serial (Absolute, Incremental) EnDat 2.2 Sinusoidal Analog hall					
Control Performance	Speed Control Range	Maximum 1 : 5000					
	Frequency Response	Maximum 1[kHz] or above (When the 19-bit serial encoder is applied)					
	Speed Variation Ratio	±0.01[%] or lower (When the load changes between 0 and 100%) ±0.1[%] or less(Temperature of 25°C[±10])					
	Torque Control Repetition Accuracy	Within ±1%					
EtherCAT Communication Specifications	Communication Standard	FoE (Firmware download) EoE (Parameter setting by UDP, Tuning, Secondary function, Parameter copy) CoE (IEC 61158 type12, IEC 61800-7 CIA 402 drive profile)					
	Physical Layer	100BASE-TX(IEEE802.3)					
	Connector	RJ45x2					
	Communication distance	Within connection between nodes 100[m]					
	DC(Distributed Clock)	By DC mode synchronism. Minimum DC cycle : 250[us]					
	LED Display	LinkAct iN, LinkAct OUT, RUN, ERR					
	Cia402 Drive Profile	Profile position mode Profile velocity mode Profile torque mode Cyclic synchronous position mode Cyclic synchronous velocity mode Cyclic synchronous torque mode Homing mode					
Digital Input / Output	Digital Input	Input voltage range : DC 12[V] ~ DC 24[V] Total 8 input channels (Allocable) Above 12 functions can be used selectively for assignment. (*POT, *NOT, *HOME, *STOP, *PCON, *GAIN2, *P_CL, *N_CL, PROBE1, PROBE2, EMG, A_RST)					
	Digital Output	Service rating: DC 24[V] ±10%, 120[] Total 4 input channels (Allocable) Above 11 functions can be used selectively for assignment. (*BRAKE±, *ALARM±, *READY±, *ZSPD±, INPOS±, TLMT±, VLMT±, INSPD±, WARN±, TGON±, INPOS±)					
Safety Function		2 input channels (STO1, STO2), 1 output channels (EDM±)					
USB Communication	Function	Firmware download, Parameter setting, Tuning, Secondary function, Parameter copy					
	Communication Standard	USB 2.0 full speed (Applies standard)					
	Connect	PC or USB storing medium					
Internal Function	Dynamic Braking	Standard built-in brake (Activated when the servo alarm goes off or when the servo is off).					
	Regenerative Braking	Default built-in (Excluding 15kW), External installation possible					
	Display Function	7 segments (5DIGIT)					
	Self-setting Function	The [MODE] key changes the content displayed in 7 segments					
	Additional Function	Auto gain tuning function					
Protection Function		Overcurrent, Overload, Overvoltage, Insufficient voltage, Main power input problem, Control power input problem, Overspeed, Motor cable, Overheat (Power module overheat, Abnormal drive operation's temp), Encoder problem, Over-regenerative, Sensor problem, Communication problem					
Operation Environment	Operating Temperature / Storage Temperature	0 ~ 50[°C] / -20 ~ 70[°C]					
	Operating Humidity / Storage Humidity	Below 80[%]RH / Below 90[%]RH (Avoid dew-condensation)					
	Environment	Indoor, Avoid corrosive, Inflammable gas or liquid, and electrically conductive dust.					

L7PA Drive

Type Name		L7PA001U	L7PA002U	L7PA004U	L7PA008U	L7PA010U	L7PA020U	L7PA035U	L7PA050U	L7PA075U	L7PA150U
Input Power	Main Power Supply	3 Phase AC200 ~ 230[V](-15 ~ +10[%]), 50 ~ 60[Hz]									
	Control Power Supply	Single phase AC200 ~ 230[V](-15 ~ +10[%]), 50 ~ 60[Hz]									
Rated Current[A]		1.4	1.7	3.0	5.2	6.75	13.5	16.7	32	39.4	76
Peak Current[A]		4.2	5.1	9.0	15.6	20.25	40.5	50.1	90.88	98.5	190
Encoder Type		Quadrature (Incremental) BiSS-B, BiSS-C (Absolute, Incremental) Tamagawa serial (Absolute, Incremental) EnDat 2.2 Sinusoidal analog hall									
Control Performance	Speed Control Range	Maximum 1 : 5000									
	Frequency Response	Maximum 1 [kHz] or above (When using 19bit serial encoder)									
	Speed Variation Ratio	± 0.01 [%] or lower [When load changes between 0 and 100%] ± 0.1 [%] or lower [Temperature 25 $\pm 10^{\circ}\text{C}$]									
	Accel/Decel Time	Straight or s-curve acceleration/Deceleration (0~10,000[ms], 0~1,000[ms] unit configurable)									
	Input Frequency	1[Mpps], Line drive / 200[kpps], Open collector									
	Input Pulse Type	Symbol + Pulse series, CW+CCW, A/B phase									
RS422 Communication Specifications	Communication Specifications	ANSI/TIA/EIA-422 standard specifications									
	Communication Protocol	MODBUS-RTU									
	Connector	RJ45x2									
	Synchro Method	Asynchronous									
	Transmission Speed	9600 / 19200 / 38400 / 57600 [bps] Can be configured at [0x3002]									
	Transmission Distance	Maximum 200 [m]									
	Power Consumption	100 [mA]									
Terminating Resistance	Dip S/W(On/Off), Built-in 120 Ω										
Input / Output Signal	Digital Input	Input voltage range : DC 12[V] ~ DC 24[V] Total 16 input channel (Allocatable) 32 function inputs can be selectively allocated (*SV_ON, *POT, *NOT, *A-RST, *START, *STOP, *REGT, *EMG, *HOME, *HSTART, *ISEL0, *ISEL1, *ISEL2, *ISEL3, *ISEL4, *ISEL5, PCON, GAIN2, P_CL, N_CL, MODE, PAUSE, ABSRQ, JSTART, JDIR, PCLR, AOVR, SPD1/LVSF1, SPD2/LVSF2, SPD3, PROBE1, PROBE2)									
	Digital Output	Use rating: DC 24[V] $\pm 10\%$, 120[mA] total 8 input channel (Allocatable) 19 function inputs can be selectively allocated (*ALARM \pm , *READY \pm , *BRAKE \pm , *INPOS1 \pm , *ORG \pm , *EOS \pm , *TGON \pm , *TLMT \pm , VLMT \pm , INSPD \pm , ZSPD \pm , WARN \pm , INPOS2 \pm , IOU0 \pm , IOU1 \pm , IOU2 \pm , IOU3 \pm , IOU4 \pm , IOU5 \pm)									
Analog Input / Output	Analog Input	Total 2 channels Analog speed override input (-10[V] ~ +10[V]) Analog torque command input (-10[V] ~ +10[V])									
	Analog Output	Total 2 channels 15 function inputs can be selectively allocated									
USB Communication	Protection	Firmware download, Parameter setting, Tuning, Auxiliary function, Parameter copy									
	Communication Specifications	Complies with USB 2.0 full speed specifications									
	Connection Device	PC or USB storage media									
Built-in Functions	Dynamic Braking	Standard built-in (Activated by servo alarm or servo OFF)									
	Regenerative Braking	Default built-in (Excluding 15kW), External installation possible									
	Display	7 segment (5 DIGIT)									
	Setting Function	Drive node address can be set using rotary switch									
	Additional Function	Gain tuning, Alarm history, JOG operation, Origin search									
	Protective Function	Excessive current, Overload, Excessive current limit, Overheating, Excessive voltage, Low voltage, Excessive, Zspeed, Encoder fail, Position following Fail, Current sensing fail									
Operation Environment	Operating Temperature / Storage Temperature	0 ~ 50[$^{\circ}\text{C}$] / -20 ~ 70[$^{\circ}\text{C}$]									
	Operating Humidity / Storage Humidity	Below 80[%]RH / Below 90[%]RH (Avoid dew-condensation)									
	Environment	Indoor, Avoid corrosive, Inflammable gas or liquid, and electrically conductive dust.									

Servo Drive

L7PB Drive

Type Name		L7PB010U	L7PB020U	L7PB035U	L7PB050U	L7PB075U	L7PB150U
Input Power	Main Power Supply	3 phase AC380 ~480[V](-15 ~ +10[%]), 50 ~ 60[Hz]					
	Control Power Supply	Single phase AC380 ~ 480[V](-15 ~ +10[%]), 50 ~ 60[Hz]					
Rated Current[A]		3.7	8	10.1	17.5	22.8	39
Peak Current[A]		11.1	24	30.3	47.25	57	97.5
Encoder Type		Universal encoder feedback quadrature (Incremental) BiSS-B, BiSS-C (Absolute, Incremental) Tamagawa serial (Absolute, Incremental) EnDat 2.2 sinusoidal analog hall					
Control Performance	Speed Control Range	Maximum 1: 5000					
	Frequency Response	Maximum 1 [kHz] or above (When using 19bit serial encoder)					
	Speed Variation Ratio	±0.01 [%] or lower [When load changes between 0 and 100%] ±0.1[%] or lower [Temperature 25 ±10°C]					
	Accel/Decel Time	Straight or s-curve acceleration/Deceleration (0~10,000[ms], 0~1,000[ms] unit configurable)					
	Input Frequency	1[Mpps], Line drive / 200[kpps], Open collector					
	Input Pulse Type	Symbol + pulse series, CW+CCW, A/B phase					
RS422 Communication Specifications	Communication Specifications	ANSI/TIA/EIA-422 standard specifications					
	Communication Protocol	MODBUS-RTU					
	Connector	RJ45x2					
	Synchro Method	Asynchronous					
	Transmission Speed	9600 /19200/38400/57600 [bps] Can be configured at [0x3002]					
	Transmission Distance	Maximum 200 [m]					
	Power Consumption	100[mA]					
Terminating Resistance	Dip S/W(On/Off), Built-in 120Ω						
Input / Output Signal	Digital Input	Input voltage range: DC 12[V] ~ DC 24[V] total 16 input channel (Allocatable) 30 function inputs can be selectively allocated (*SV_ON, *POT, *NOT, *A-RST, *START, *STOP, *REGT, *EMG, *HOME, *HSTART, *ISEL0, *ISEL1, *ISEL2, *ISEL3, *ISEL4, *ISEL5, PCON, GAIN2, P_CL, N_CL, PAUSE, ABSRQ, JSTART, JDIR, PCLR, SPD1/LVFS1, SPD2/LVFS2, SPD3, AOVR, MODE,)					
	Digital Output	Use rating : DC 24[V] ±10%, 120[mA] total 8 input channel (Allocatable) 19 function inputs can be selectively allocated (*ALARM±, *READY±, *BRAKE±, *INPOS1±, *ORG±, *EOS±, *TGON±, *TLMT±, VLMT±, INSPD±, ZSPD±, WARN±, INPOS2±, IOUT0±, IOUT1±, IOUT2±, IOUT3±, IOUT4±, IOUT5±)					
Analog Input/Output	Analog Input	Total 2 channels Analog speed override input (-10[V] ~ +10[V]) Analog torque command input (-10[V] ~ +10[V])					
	Analog Output	Total 2 channels 15 function inputs can be selectively allocated					
USB Communication	Protection	Firmware download, Parameter setting, Tuning, Auxiliary function, Parameter copy					
	Communication Specifications	Complies with USB 2.0 full speed specifications					
	Connection Device	PC or USB storage media					
Built-in Functions	Dynamic Braking	Standard built-in(Activated by servo alarm or servo OFF)					
	Regenerative Braking	Default built-in (Excluding 15kW), External installation possible					
	Display	7 segment (5 DIGIT)					
	Setting Function	Drive node address can be set using rotary switch					
	Additional Function	Gain tuning, Alarm history, JOG operation, Origin search					
Protective Function	Excessive current, Overload, Excessive current Limit, Overheating, Excessive voltage, Low voltage, Excessive speed, Encoder fail, Position following fail, Current sensing fail						
Operation Environment	Operating Temperature / Storage Temperature	0 ~ 50[°C] / -20 ~ 70[°C]					
	Operating Humidity / Storage Humidity	Below 80[%]RH / Below 90[%]RH (Avoid dew-condensation)					
	Environment	Indoor, Avoid corrosive, Inflammable gas or liquid, and electrically conductive dust.					

L7NHFA Drive

Type Name		L7NHFA010U	L7NHFA020U	L7NHFA035U	L7NHFA150U
Input Power	Main Power Supply	3 phase AC200 ~ 230[V](-15 ~ +10[%]), 50 ~ 60[Hz]			
	Control Power Supply	Single phase AC200 ~ 230[V](-15 ~ +10[%]), 50 ~ 60[Hz]			
Rated Current[A]		6.75	16.7	32	39.4
Peak Current[A]		20.25	50.1	90.88	98.5
1st Encoder Encoder A		Quadrature (Incremental) BiSS-B, BiSS-C (Absolute, Incremental) Tamagawa serial (Absolute, Incremental) EnDat 2.2, Sinusoidal, Analog hall			
2nd Encoder Encoder B		Quadrature (Incremental), SSI sinusoidal, Analog hall (Analog to BiSS converter)			
Control Performance	Speed Control Range	Maximum 1: 5000			
	Frequency Response	Maximum 1[kHz] or above (When the 19-bit serial encoder is applied)			
	Speed Variation Ratio	±0.01[%] or lower (When the load changes between 0 and 100%) ±0.1[%] or less (Temperature of 25°C[±10])			
	Torque Control Repetition Accuracy	Within ±1%			
	Input Frequency	4[Mpps], Lind drive			
	Input Pulse Method	Symbol+pulse series, CW+CCW, PhaseA/B			
EtherCAT Communication Specifications	Communication Standard	FoE (Firmware download) EoE (Parameter setting by UDP, Tuning, Secondary function, Parameter copy) CoE (IEC 61158 type12, IEC 61800-7 CIA 402 drive profile)			
	Physical Layer	100BASE-TX (IEEE802.3)			
	Connector	RJ45x2			
	Communication Distance	Within connection between nodes 100[m]			
	DC(Distributed Clock)	By DC mode synchronism. Minimum DC cycle : 250[us]			
	LED Display	LinkAct iN, LinkAct OUT, RUN, ERR			
	Cia402 Drive Profile	Profile position mode, Profile velocity mode. Profile torque mode, Cyclic synchronous position mode Cyclic synchronous velocity mode, Cyclic synchronous torque mode, Homing mode			
Digital Input / Output	Digital Input	Input voltage range : DC12[V] ~ DC 24[V] Total 6 input channels (Allocable) Above 15 functions can be used selectively for assignment. (*POT, *NOT, *HOME, *STOP, *PCON, *GAIN2, *P_CL, *N_CL, *PROBE1, *PROBE2, *EMG, *A_RST, *SV_ON, *LVSF, *LVSF2) * Default signal			
	Digital Output	Total 3 input channels (Allocable) Total 11 output can be used selectively for assignment. (*BRAKE±, *ALARM±, *READY±, *ZSPD±, *INPOS±, *TLMT±, *VLMT±, *INSPD±, *WARN±, *TGON±, *INPOS2±) * Default signal			
	Analog Output	Total 2 channels (Allocable) Total 25 output can be used selectively for assignment.			
Safety Function		2 input channels (STO1, STO2)			
USB Communication	Function	Firmware download, Parameter setting, Tuning, Auxiliary function, Parameter copy			
	Communication Specifications	USB 2.0 full speed (Applies standard)			
	Connect	PC or USB storage media			
Internal Function	Dynamic Braking	Standard built-in brake (Activated when the servo alarm goes off or when the servo is off).			
	Regenerative Braking	Default built-in(Excluding 15kW), External installation possible			
	Display Function	7 segments (5DIGIT)			
	Self-setting Function	The [MODE] key changes the content displayed in 7 segments			
	Additional Function	Auto gain tuning function			
Protection Function		Overcurrent, Overload, Overvoltage, Insufficient voltage, Overspeed, Overheat (Power module overheat, Abnormal drive operation's temp), Encoder problem, Position tracking, Problem, Current sensing problem			
Operation Environment	Operating Temperature / Storage Temperature	0 ~ 50[°C] / -20 ~ 70[°C]			
	Operating Humidity / Storage Humidity	Below 80[%]RH / Below 90[%]RH (Avoid dew-condensation)			
	Environment	Indoor, Avoid corrosive, Inflammable gas or liquid, and electrically conductive dust.			

Servo Drive

L7C Drive

Item	Type Name	L7CA001U	L7CA002U	L7CA004U	L7CA008U	L7CA010U
Input power		Single phase AC200 ~ 230[V] (-15~+10%), 50~60[Hz]				
Rated Current[A]		1.4	1.7	3.0	5.2	6.75
Peak Current[A]		4.2	5.1	9.0	15.6	20.25
Encoder Type		Quadrature (Incremental), Biss-B, Biss-C (Absolute, Incremental)				
Control Performance	Speed Control Range	Maximum 1:5000				
	Frequency Response	Maximum 1[KHz] or above (When using 19bit serial encoder)				
	Speed Variation Ratio	±0.01 [%] or lower [When load changes between 0 and 100%] ±0.1[%] or lower [Temperature 25 ±10°C]				
	Accel/Decel Time	Straight or s-curve acceleration/Deceleration (0-10,000[ms], Possible to be set by one[ms] unit)				
	Input Frequency	1[Mpps], Line driver / 200[kpps], Open collector				
RS-422	Input Pulse Type	Symbol + pulse series, CW+CCW, A/B phase				
	Specification	ANSI/TIA/EIA-422 standard specifications				
	Protocol	MODBUS-RTU				
	Synchro Method	Asynchronous				
	Power Consumption	100[mA]				
	Transmission Speed	9,600/19,200/38,400/57,600bps				
	Distance	Maximum 200[m]				
Terminating Resistance	Connecting the outside connector (CN1 7pin, 28pin connection), Built-in 120Ω					
EtherCAT Communication Specifications	Digital Input	Input voltage range : DC12V ~ DC24V Total 10 input channels (Allocable) Total 34 function's input can be used selectively for assignment. (*SV_ON, *SPD/LVSF1, *SPD2/LVSF2, *SPD3, *A-RST, *JDIR, *POT, *NOT, *EMG, *STOP, START, REGT, HOME, HSTART, ISEL0, ISEL1, ISEL2, ISEL3, ISEL4, ISEL5, PCON, GAIN2, P_CL, N_CL, MODE, PAUSE, ABSRQ, JSTART, PCLR, AOVR, INHIBIT, EGEAR1, EGEAR2, ABS_RESET) * Basic allocation signal				
	Digital Output	Service rating : DC24V ±10%, 120mA 5 of 8 input channels are allocable, 3 channels are fixed with AL00, AL01, AL02 Total 19 function's input can be used selectively for assignment. (*ALARM, *READY, *ZSPD, *BREAK, *INPOS1, ORG, EOS, TGON, TLMT, VLMT, INSPD, WARN, INPOS2, IOUT0, IOUT1, IOUT2, IOUT3, IOUT4, IOUT5) * Basic allocation signal				
Analog Output		2 channel Analog speed input (Command/Override) ±10V Analog torque input (Command/Limit) ±10V				
USB Communication	Function	PC				
	Communication Standard	USB 2.0 full speed (Applies standard)				
Internal Function	Connect	PC, USB 2.0 full speed (Applies standard)				
	Dynamic Braking	Standard built-in brake (Activated when the servo alarm goes off or when the servo is off)				
	Regenerative Braking	Both default built-in and external installation possible				
	Display Function	7 segments (5DIGIT)				
	Self-setting Function	Gain tuning, Alarm history, JOG operation, Origin search				
Operation Environment	Protection Function	Excessive current/Voltage/Overload/Overheating/Speed, Excessive current limit, Low voltage, Encoder/Position following/Current sensing fail				
	Operating Temperature / Storage Temperature	0~50°C / -20 ~ 65°C				
	Operating Humidity / Storage Humidity	Below 80[%]RH / Below 90[%]RH (Avoid dew-condensation)				
Environment		Indoor, Avoid corrosive, Inflammable gas or liquid, and electrically conductive dust.				

Drive Combination Table

iX7NHA

Rated Speed (rpm)	Maximum Speed (rpm)	Flange	Motor	iX7 Drive	Encoder Cable		iX7 Power Cable	iX7 Power + Brake	Brake
					Serial	Absolute			
3,000	5,000	□40	FALR5A	iX7NHA001U	APCS-E□□□ES-□	APCS-E□□□ES-□1	APCS-P□□□LSX	-	APCS-B□□□QS-□
		□40	FAL01A	iX7NHA001U					
		□40	FAL015A	iX7NHA004U					
		□60	FBL01A	iX7NHA001U					
		□60	FBL02A	iX7NHA002U					
		□60	FBL04A	iX7NHA004U					
		□80	FCL04A	iX7NHA004U					
		□80	FCL06A	iX7NHA008U					
		□80	FCL08A	iX7NHA008U					
		□80	FCL10A	iX7NHA010U					
		□130	FE09A	iX7NHA010U	APCS-E□□□□DS	APCS-E□□□□DS1	APCS-P□□□HSX1	APCS-P□□□NBX1	-
		□130	FE15A	iX7NHA020U					
		□130	FE22A	iX7NHA020U			APCS-P□□□HSX	APCS-P□□□NBX	
		□130	FE30A	iX7NHA035U					
2,000	3,000	□130	FE06D	iX7NHA008U	APCS-E□□□□DS	APCS-E□□□□DS1	APCS-P□□□HSX1	APCS-P□□□NBX1	-
		□130	FE11D	iX7NHA010U					
		□130	FE16D	iX7NHA020U			APCS-P□□□HSX	APCS-P□□□NBX	
		□130	FE22D	iX7NHA020U					
1,500	3,000	□130	FE05G	iX7NHA008U	APCS-E□□□□DS	APCS-E□□□□DS1	APCS-P□□□HSX1	APCS-P□□□NBX1	-
		□130	FE09G	iX7NHA010U					
		□130	FE13G	iX7NHA020U			APCS-P□□□HSX	APCS-P□□□NBX	
		□130	FE17G	iX7NHA020U					
1,000	2,000	□130	FE03M	iX7NHA004U	APCS-E□□□□DS	APCS-E□□□□DS1	APCS-P□□□HSX1	APCS-P□□□NBX1	-
		□130	FE06M	iX7NHA008U					
		□130	FE09M	iX7NHA010U			APCS-P□□□HSX	APCS-P□□□NBX	
		□130	FE12M	iX7NHA020U					

Servo

Drive Combination Table

iX7NHA DD Motor

Rated Speed (rpm)	Maximum Speed (rpm)	External Diameter Of Motor(φ)	Motor	Drive	Encoder Cable		iX7 Power Cable	iX7 Power + Brake Cable	Brake
					Serial	Absolute			
200	500	135φ	DB03D	iX7NHA001U	APCS-E□□□ZS	-	APCS-P□□□YSX	-	-
			DB06D	iX7NHA002U					
			DB09D	iX7NHA004U					
	175φ	DC06D	iX7NHA002U						
		DC12D	iX7NHA004U						
		DC18D	iX7NHA008U						
	400	230φ	DD12D	iX7NHA004U					
	400		DD22D	iX7NHA008U					
			DD34D	iX7NHA010U					
	300	290φ	DE40D	iX7NHA010U					
DE60D			iX7NHA020U						
150	250	360φ	DFA1G	iX7NHA020U	APCS-P□□□ZSX				
			DFA6G	iX7NHA035U					
50	100	380φ	DGC3S	iX7NHA020U					
200	500	135φ	DFB03D	iX7NHA001U	APCS-E□□□ZS1	-	APCS-P□□□YSX1	-	-
		175φ	DFC06D	iX7NHA002U					
		230φ	DFD12D	iX7NHA004U					

L7NHA

Rated Speed (rpm)	Maximum Speed (rpm)	Flange	Motor	Drive	Encoder Cable		Power	Power + Brake	Brake							
					Serial	Absolute										
3,000	5,000	□40	FALR5A	L7NHA001U	APCS-E□□□ES-□	APCS-E□□□ES-□1	APCS-P□□□LS-□	-	APCS-B□□□QS-□							
		□40	FAL01A	L7NHA001U												
		□40	FAL015A	L7NHA004U												
		□60	FBL01A	L7NHA001U												
		□60	FBL02A	L7NHA002U												
		□60	FBL04A	L7NHA004U												
		□80	FCL04A	L7NHA004U												
		□80	FCL06A	L7NHA008U												
		□80	FCL08A	L7NHA008U												
		□80	FCL10A	L7NHA010U												
		□130	FE09A	L7NHA010U												
		□130	FE15A	L7NHA020U												
		□130	FE22A	L7NHA020U												
		□130	FE30A	L7NHA035U												
		□180	FF30A	L7NHA035U												
2,000	3,000	□80	FCL03D	L7NHA004U	APCS-E□□□ES-□	APCS-E□□□ES-□1	APCS-P□□□LS-□	-	APCS-B□□□QS-□							
		□80	FCL05D	L7NHA008U												
		□80	FCL06D	L7NHA008U												
		□80	FCL07D	L7NHA008U												
		□130	FE06D	L7NHA008U												
		□130	FE11D	L7NHA010U												
		□130	FE16D	L7NHA020U												
		□130	FE22D	L7NHA020U												
		□180	FF22D	L7NHA020U												
		□180	FF35D	L7NHA035U												
		□180	FF55D	L7NHA050U												
		1,500	2,500	□180						FF75D	L7NHA075U	APCS-E□□□DS	APCS-E□□□DS1	APCS-P□□□HS1	APCS-P□□□NB1	-
				□220						FG22D	L7NHA020U					
				□220						FG35D	L7NHA035U					
				□220						FG55D	L7NHA050U					
□220	FG75D			L7NHA075U												
□220	FG110D			L7NHA150U												
1,000	2,000			□130	FE05G	L7NHA008U	APCS-E□□□DS	APCS-E□□□DS1	APCS-P□□□HS1	APCS-P□□□NB1	-					
				□130	FE09G	L7NHA010U										
				□130	FE13G	L7NHA020U										
				□130	FE17G	L7NHA020U										
				□180	FF20G	L7NHA020U										
				□180	FF30G	L7NHA035U										
				□180	FF44G	L7NHA050U										
				□180	FF60G	L7NHA075U										
				□180	FF75G	L7NHA075U										
		□220	FG20G	L7NHA020U												
		□220	FG30G	L7NHA035U												
		□220	FG44G	L7NHA050U												
		□220	FG60G	L7NHA075U												
		□220	FG85G	L7NHA150U												
		□220	FG110G	L7NHA150U												
1,000	2,000	□130	FE03M	L7NHA004U	APCS-E□□□DS	APCS-E□□□DS1	APCS-P□□□HS1	APCS-P□□□NB1	-							
		□130	FE06M	L7NHA008U												
		□130	FE09M	L7NHA010U												
		□130	FE12M	L7NHA020U												
		□180	FF12M	L7NHA020U												
		□180	FF20M	L7NHA020U												
		□180	FF30M	L7NHA035U												
		□180	FF44M	L7NHA050U												
		□220	FG12M	L7NHA020U												
		□220	FG20M	L7NHA020U												
		□220	FG30M	L7NHA035U												
		□220	FG44M	L7NHA050U												
		□220	FG60M	L7NHA075U												
		1,000	2,000	□130						FE03M	L7NHA004U	APCS-E□□□DS	APCS-E□□□DS1	APCS-P□□□HS1	APCS-P□□□NB1	-
				□130						FE06M	L7NHA008U					
□130	FE09M			L7NHA010U												
□130	FE12M			L7NHA020U												
□180	FF12M			L7NHA020U												
□180	FF20M			L7NHA020U												
□180	FF30M			L7NHA035U												
□180	FF44M			L7NHA050U												
□220	FG12M			L7NHA020U												
□220	FG20M			L7NHA020U												
□220	FG30M			L7NHA035U												
□220	FG44M			L7NHA050U												
□220	FG60M			L7NHA075U												
1,000	2,000			□130	FE03M	L7NHA004U	APCS-E□□□DS	APCS-E□□□DS1	APCS-P□□□HS1	APCS-P□□□NB1	-					
				□130	FE06M	L7NHA008U										
		□130	FE09M	L7NHA010U												
		□130	FE12M	L7NHA020U												
		□180	FF12M	L7NHA020U												
		□180	FF20M	L7NHA020U												
		□180	FF30M	L7NHA035U												
		□180	FF44M	L7NHA050U												
		□220	FG12M	L7NHA020U												
		□220	FG20M	L7NHA020U												
		□220	FG30M	L7NHA035U												
		□220	FG44M	L7NHA050U												
		□220	FG60M	L7NHA075U												

Servo

Drive Combination Table

L7NHA DD Motor

Rated Speed (rpm)	Maximum Speed (rpm)	External Diameter Of Motor(Φ)	Motor	Drive	Encoder Cable		Power	Power + Brake	Brake
					Serial	Absolute			
200	500	135Φ	DB03D	L7NHA001U	APCS-E□□□ZS	-	APCS-PN□□□YS	-	-
			DB06D	L7NHA002U					
			DB09D	L7NHA004U					
		175Φ	DC06D	L7NHA002U					
			DC12D	L7NHA004U					
			DC18D	L7NHA008U					
	400	230Φ	DD12D	L7NHA004U					
	500		DD22D	L7NHA008U					
	400		DD34D	L7NHA010U					
	300	290Φ	DE40D	L7NHA010U					
			DE60D	L7NHA020U					
	150	250	360Φ	DFA1G					
			DFA6G	L7NHA035U					
50	100	380Φ	DGC3S	L7NHA020U	APCS-E□□□ZS1	-	APCS-PN□□□YS1	-	-
200	500	135Φ	DFB03D	L7NHA001U					
		175Φ	DFC06D	L7NHA002U					
		230Φ	DFD12D	L7NHA004U					

L7NHB

Rated Speed (rpm)	Maximum Speed (rpm)	Flange	Motor	Drive	Encoder Cable		Power	Power + Brake	Brake
					Serial	Absolute			
3,000	5,000	□130	FEP09A	L7NHB010U	APCS-E□□□DS	APCS-E□□□DS1	APCS-P□□□HS1	APCS-P□□□NB1	
		□130	FEP15A	L7NHB020U					
		□130	FEP22A	L7NHB035U					
		□130	FEP30A	L7NHB035U					
		□180	FFP30A	L7NHB035U					
		□180	FFP50A	L7NHB050U					
2,000	3,000	□130	FEP06D	L7NHB010U					
		□130	FEP11D	L7NHB010U					
		□130	FEP16D	L7NHB020U					
		□130	FEP22D	L7NHB020U					
		□180	FFP22D	L7NHB020U					
		□180	FFP35D	L7NHB035U					
	2,500	2,500	□180	FFP55D			L7NHB050U		
			□180	FFP75D			L7NHB075U		
			□220	FGP22D			L7NHB020U		
			□220	FGP35D			L7NHB035U		
			□220	FGP55D			L7NHB050U		
			□220	FGP75D			L7NHB075U		
1,500	3,000	□130	FEP05G	L7NHB010U					
		□130	FEP09G	L7NHB010U					
		□130	FEP13G	L7NHB020U					
		□130	FEP17G	L7NHB020U					
		□180	FFP20G	L7NHB020U					
		□180	FFP30G	L7NHB035U					
	2,000	2,700	□180	FFP44G	L7NHB050U				
			□180	FFP60G	L7NHB075U				
			□180	FFP75G	L7NHB075U				
			□220	FGP20G	L7NHB020U				
			□220	FGP30G	L7NHB035U				
			□220	FGP44G	L7NHB050U				
		2,500	2,500	□220	FGP60G	L7NHB075U			
				□220	FGP85G	L7NHB150U			
				□220	FGP110G	L7NHB150U			
				□220	FGP150G	L7NHB150U			
				□220	FGP20M	L7NHB020U			
				□220	FGP30M	L7NHB035U			
1,000	2,000	□130	FEP03M	L7NHB010U					
		□130	FEP06M	L7NHB010U					
		□130	FEP09M	L7NHB010U					
		□130	FEP12M	L7NHB020U					
		□180	FFP12M	L7NHB020U					
		□180	FFP20M	L7NHB020U					
	2,000	2,000	□180	FFP30M	L7NHB035U				
			□180	FFP44M	L7NHB050U				
			□220	FGP12M	L7NHB020U				
			□220	FGP20M	L7NHB020U				
			□220	FGP30M	L7NHB035U				
			□220	FGP44M	L7NHB050U				
		□220	FGP60M	L7NHB150U					

Servo

Drive Combination Table

L7CA

Rated Speed (rpm)	Maximum Speed (rpm)	Flange	Motor	Drive	Encoder Cable		Power	Power + Brake	Brake
					Serial	Absolute			
3,000	5,000	□40	FALR5A	L7CA001U	APCS-E □□□ES	APCS-E □□□ES1	APCS-P□□□LSC	-	APCS-B□□□QS
		□40	FAL01A	L7CA001U					
		□40	FAL015A	L7CA002U					
		□60	FBL01A	L7CA001U					
		□60	FBL02A	L7CA002U					
		□60	FBL04A	L7CA004U					
		□80	FCL04A	L7CA004U					
		□80	FCL06A	L7CA008U					
		□80	FCL08A	L7CA008U					
		□80	FCL10A	L7CA010U					
2,000	2,500	□80	FCL03D	L7CA004U	APCS-E □□□ES	APCS-E □□□ES1	APCS-P□□□LSC	-	APCS-B□□□QS
		□80	FCL05D	L7CA008U					
		□80	FCL06D	L7CA008U					
		□80	FCL07D	L7CA008U					



Gearbox

Precision Planetary Gearbox



LS planetary gearbox is a device that transfers increased torque to the Application by decreasing motor speed.

LS thrives to provide total solution in the industrial automation market by having a wide range of products with high performance and promised quality, including motion controllers to servo drives, motor.



Special Features



High Performance by LS Strict Quality Process

- Low noise level
- Best-in-class backlash
- High output torque
- High efficiency



Easy Installation with Various Motors and Manufacturing by Korea Technology.

- Competitive price
- Short delivery



Variable Gear Ratios

- Straight type : 3 : 1 ~ 100 : 1
- Angle type : 3 : 1 ~ 200 : 1



Application

- Packaging machines
- Semiconductor machines
- Logistics machines
- FPD/LCD machines

Gear Series

Spur Gear Series

- SSS Series
- SSO Series
- SSR Series
- SAS Series
- SAO Series
- SAR Series



Helical Gear Series

- MSS Series
- MSR Series
- MSO Series
- HSS Series
- HSR Series
- HSW Series
- HSD Series
- MAS Series
- MAR Series
- MAO Series
- HAS Series
- HAR Series
- HAW Series
- HAD Series



Dimension

XGK/XGI/XGR

Power

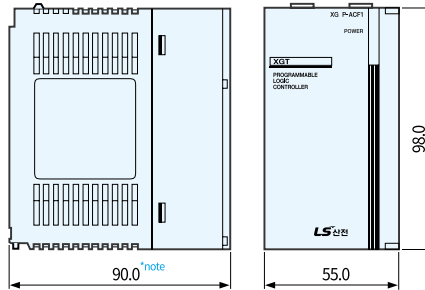

CPU, I/O

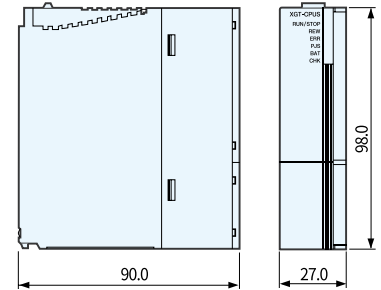

*note) XGP-AC23:110.0

XGB

XBC/XEC DN32U

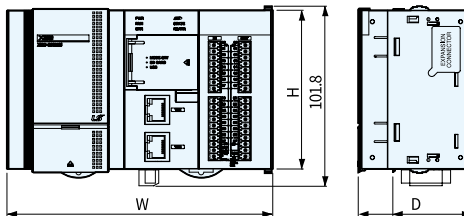

XBM H2, HP

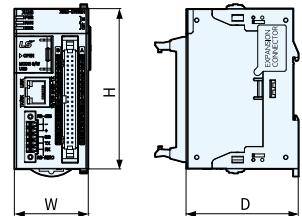

XBC/XEC DR32H

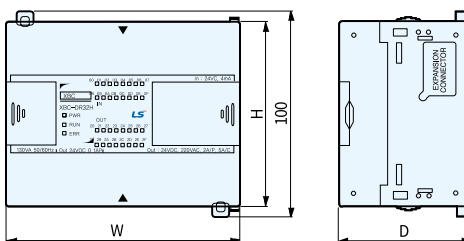

XBM DN16S

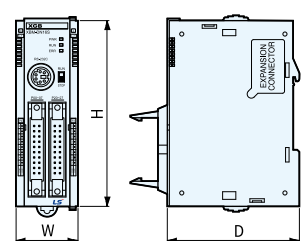

Item	Type	Model	W	H	D	
CPU	XBC/XEC "U"	DN, DR 32U	150	90(100)	64	
		DN, DR 32UP	185			
		DN, DR 32UA	185			
	XBC/XEC "H"	DR(N/P)32H	114			
		DR(N/P)64H	180			
	XBC/XEC "SU"	DR, DN, DP 20/30SU	135			
		DR, DN, DP 40SU	161			
		DR, DN, DP 60SU	210			
	XBC/XEC "E"	DR, DN, DP 10/14E	100			
		DR, DN, DP 20/30E	135			
XBM/XEM H2, HP	DN/DP32H2, DN/DP32HP	41.5	90	64		
	XBM(Slim)	DR16S, DN16S, DN32S	30		90 (100)	
I/O	Expansion I/O	DC32A	20	90	63	
		TN32A				
		TP32A				
		DC08A				
		DC16A(B)				
	Special module	TN08A	27		90	63
		TN(P) 16A				
	Relay I/O	Special module	27		90	63
		DR16A / RY16A / RY08A (B)				
	Network module	EIPT / EIMT/F/H / EMTA C41A,C21A,CMEA,CSEA,PMEC	27		90	63

Dimension

Smart I/O

Input 16pt, output TR

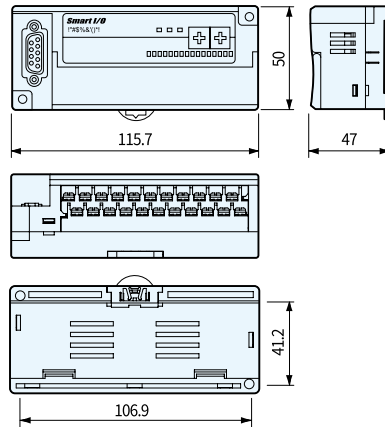

Input 32pt, TR output, Relay output 16pt, analog input / output

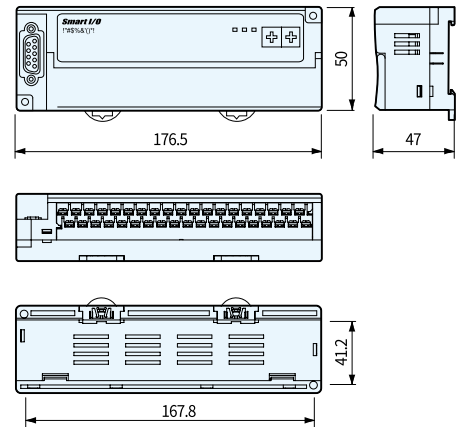

XRL-BSSA

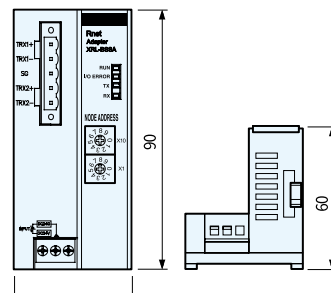

XEL-BSSCT

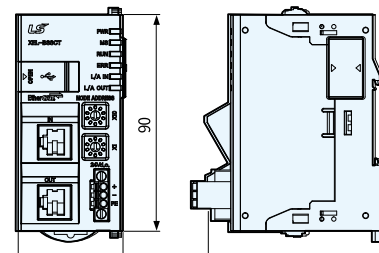

XMC

XMC-E32A/E16A/E08A/E32C

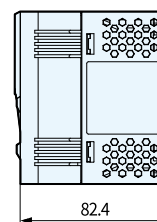
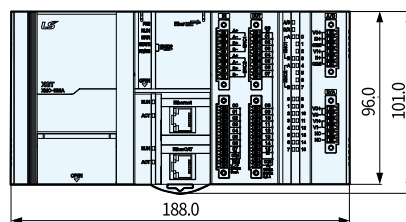
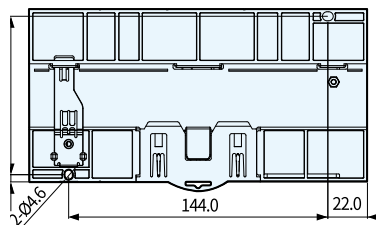

XGT Panel

iXP2-0800

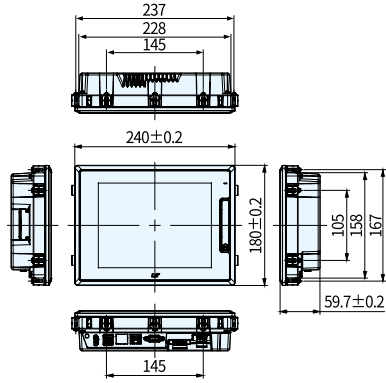

iXP2-1000

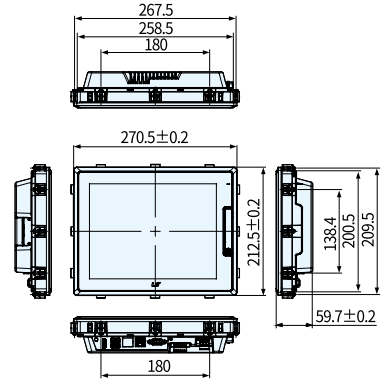

iXP2-1200

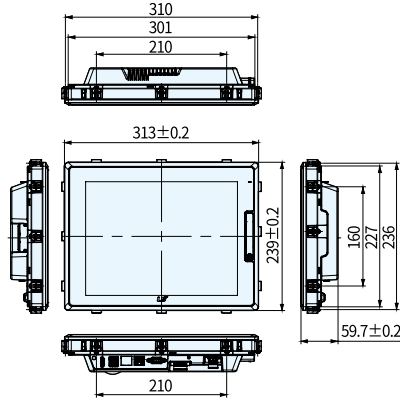

iXP2-1500

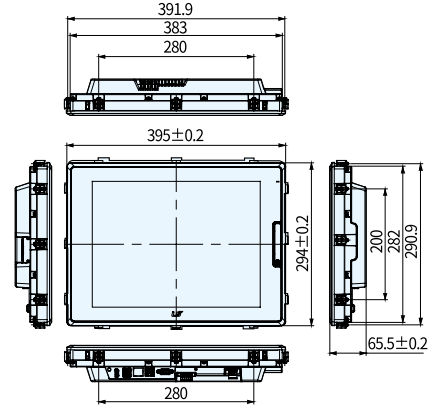

eXP20-TTA

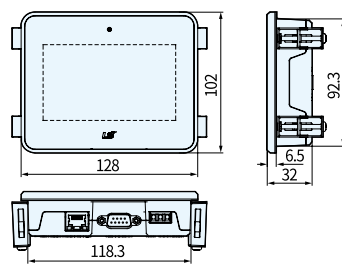

eXP30-TTA

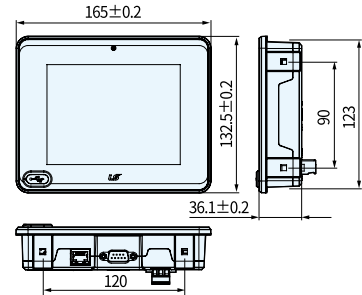

eXP40-TTA

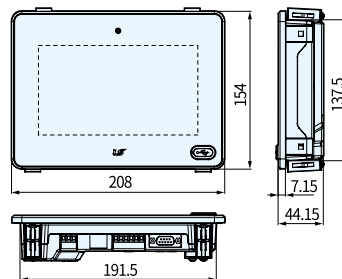

eXP60-TTA

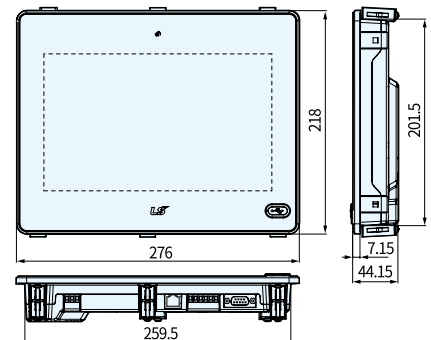

Memo



SOLUTION SQUARE

EVERYTHING ABOUT AUTOMATION ENGINEERING



SOLUTION SQUARE provides technical information and training materials across a wide range of automation technologies. You can build up your knowledge in the open community by sharing information and solutions with practical engineers.

SOLUTION SQUARE

Engineering Software-associated Services

Linked with Automation Software

Users can access graphic libraries and samples in the engineering software in a few clicks.



Simple Software Updates

Check the latest information and keep your software up-to-date through the SOLUTION SQUARE.



Quick and Easy Search for Automation Technologies

Getting Effective Search Results

Quick and easy search for up-to-date contents of products and technologies



Open Community

Sharing knowledge and information of automation with practical engineers



Mobile Friendly

Optimized for web, mobile, and tablet, and easy and fast to use anywhere and anytime



Search



SOLUTION SQUARE

on Google. Visit at sol.ls-electric.com





C/Montcada 7, Pol. Ind. Les Pereres
08130 Santa Perpètua de Mogoda (Barcelona) SPAIN
Tel. (+34) 935 748 206
info@vectorenergy.com

www.vectorenergy.com